

EVIDENCE-BASED SPECIALLY DESIGNED INSTRUCTION IN MATHEMATICS

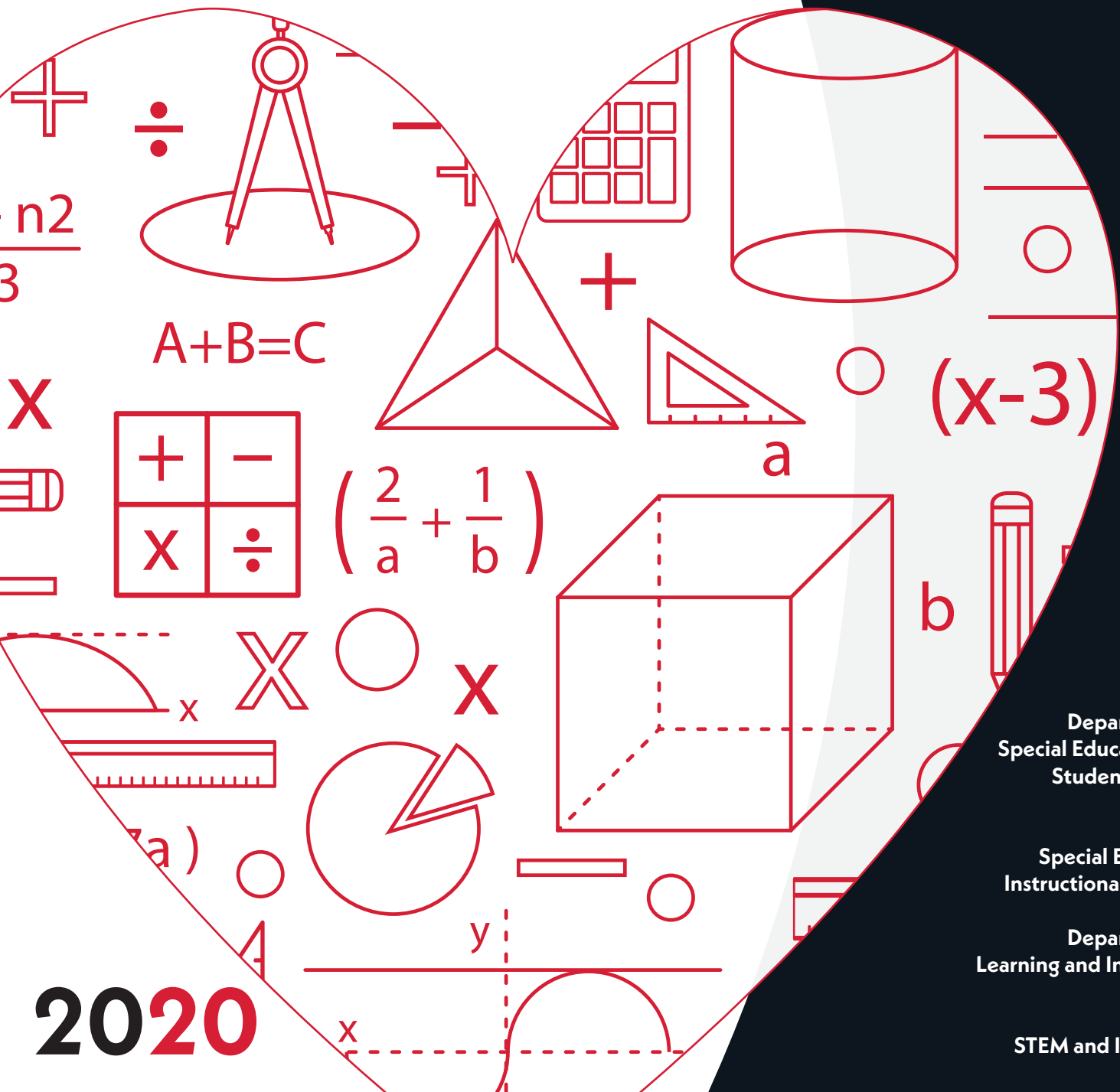

RESOURCE GUIDE



Department of
Special Education and
Student Services

Office of
Special Education
Instructional Services

Department of
Learning and Innovation

Office of
STEM and Innovation

2020

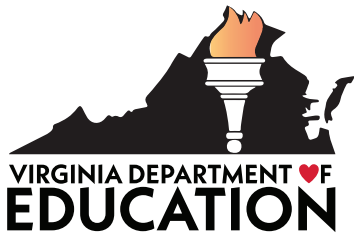

VIRGINIA EDUCATION LEADERSHIP



Ralph Northam
Governor of Virginia



Atif Qarni
Secretary of Education



Dr. James F. Lane
Superintendent
of Public Instruction



Jenna Conway
Chief School
Readiness Officer

MISSION

The mission of the Virginia Department of Education is to advance equitable and innovative learning.

VISION

Virginia will maximize the potential of all learners.

VIRGINIA STATE BOARD OF EDUCATION



Daniel A. Gecker
President



Diane T. Atkinson
Vice President

CORE SKILLS

The 5-C's are core skills that students and educators should possess:

- Critical Thinking
- Creative Thinking
- Communication
- Collaboration
- Citizenship



Dr. Francisco
Durán



Anne B.
Holton



Dr. Tammy
Mann

CORE VALUES

Core Values are values that every employee of VDOE should embody:

- Inclusion
- Excellence
- Service
- Optimism



Dr. Keisha
Pexton



Pamela
Davis-Vaught



Dr. Jamelle S.
Wilson

VIRGINIA IS FOR *all* LEARNERS

ACKNOWLEDGEMENTS

The Virginia Department of Education (VDOE) wishes to acknowledge all those who provided assistance in the development and review of this resource guide, including parents, VDOE Training and Technical Assistance Centers (TTAC), mathematics and special educators, community stakeholders, professional organizations, and university faculty.

PRIMARY CO-AUTHORS

KATHERINE BERRY, ED.D.

Department of Special Education
University of Texas at Austin

SARAH POWELL, PH.D.

Department of Special Education
University of Texas at Austin

VIRGINIA DEPARTMENT OF EDUCATION

JAMES F. LANE, ED.D.

Superintendent of Public Instruction

SAMANTHA HOLLINS, PH.D.

Assistant Superintendent
Special Education and Student Services

MICHAEL BOLLING, M.ED.

Assistant Superintendent
Department of Learning and Innovation

PATRICIA ABRAMS, ED.D.

Director
Special Education Instructional Services

TINA MANGLICMOT, ED.D.

Director
Office of STEM and Innovation

TERESA LEE, ED.D.

Coordinator
Special Education Instructional Services

TINA MAZZACANE, M.ED.

K-12 Mathematics Coordinator
Office of STEM and Innovation

DEBRA DELOZIER, M.ED.

Mathematics Specialist
Office of STEM and Innovation

KRISTIN WILLIAMS, M.S.

Mathematics and Special Education Specialist
Office of STEM and Innovation

PREFACE

The vision for K-12 mathematics education in the Commonwealth of Virginia is that all students have access to high-quality, equitable, and engaging mathematics instruction. Students participate in relevant learning opportunities that develop both conceptual and procedural understanding. Teachers develop classroom communities that promote student ownership of learning through the use of mathematical discourse, problem solving, and rich tasks. Students and teachers exemplify resilience and a growth mindset, believing that all students can learn mathematics at high levels. This vision is for all students, including students with disabilities and diverse learning needs, and spans across the continuum of all settings.

According to the Individuals with Disabilities Education Improvement Act of 2004 (IDEA 2004), extensive research and experience has demonstrated that the education of children with disabilities can be made more effective with maintaining high expectations for students while ensuring their access to the general education curriculum in the regular classroom as appropriate. [The Regulations Governing Special Education Programs for Children with Disabilities in Virginia](#) further explains that Least Restrictive Environment (LRE) means that to the maximum extent appropriate, children with disabilities, including children in public or private institutions or other care facilities, are educated with children who are not disabled, and that special classes, separate schooling or other removal of children with disabilities from the regular educational environment occurs only when the nature or severity of the disability is such that education in regular classes with the use of supplementary aids and services cannot be achieved satisfactorily (34 CFR 300.114 through 34 CFR 300.120). Review of school divisions' LRE data in 2017-2018 Virginia Department of Education (VDOE) [Special Education Annual Performance Report](#) shows that 68% of students with disabilities in Virginia's classrooms are spending at least 80% of their day in the general classroom. However, according to the [2018-2019 State Performance Report](#), approximately 55% of students with disabilities passed the Virginia Standards of Learning assessments in mathematics. Furthermore, statewide data show that achievement gaps in mathematics continue to exist for students with disabilities across the state.

This discrepancy in data may indicate that educators need more support and guidance in providing specially designed instruction and appropriate accommodations to students with disabilities in the general classroom. In an effort to enhance the performance of students with disabilities in the mathematics' classrooms, this resource guide serves as a resource for educators, administrators, and parents to address the educational needs of students with mathematics disability and/or mathematics difficulty.

This resource guide provides an overview of five evidence-based strategies that educators can utilize to support students with mathematics disability or difficulty at any grade. When delivering mathematics instruction to students with mathematics difficulty at any grade level, teachers should incorporate the following practices, all of which have a strong evidence base: Explicit Instruction; Formal Mathematical Language; Concrete-Representational-Abstract Connections; Fact and Computational Fluency; and Word-Problem Solving. Each of these practices will be addressed in this resource guide.

Essentially, this resource guide, along with the companion, [Students with Disabilities in Mathematics Frequently Asked Questions Document](#), is intended to support any student who experiences mathematics difficulty – with or without disability identification- in any setting. For those schools who implement [Virginia Tiered System of Supports \(VTSS\)](#), many of the strategies outlined in the Frequently Asked Questions document could support Tier 1 instruction, while many of the strategies outlined in this resource guide could support Tier 2 and Tier 3 instruction.

The Virginia Department of Education (VDOE) and its Department of Special Education and Student Services and Department of Learning and Innovation is committed to ensuring that the public education system is positioned to advance equitable academic outcomes by providing access to learning environments that meet the needs of its diverse student population. The Evidence-Based Specially Designed Instruction in Mathematics Resource Guide aligns with those efforts as it outlines effective supports for students with learning disabilities in mathematics and offers support to school divisions and parents seeking to improve outcomes in mathematics for students with disabilities. It also serves as a reference for professional development and technical assistance from the VDOE.

CONTENTS

ACKNOWLEDGEMENTS	3
PREFACE	4
SECTION I: EXPLICIT INSTRUCTION	6
Definition of Explicit Instruction	6
Modeling	6
Supports During Modeling	7
Practice	9
Supports During Practice	10
Resources	11
SECTION II: FORMAL MATHEMATICAL LANGUAGE	12
Formal Mathematics Language Strategies	14
Resources	17
SECTION III: CONCRETE, REPRESENTATIONAL, AND ABSTRACT CONNECTIONS	18
Concrete, Representational, and Abstract Connections	18
The Benefits of C-R-A Connections	19
Resources	24
SECTION IV: FACT AND COMPUTATIONAL FLUENCY	25
Definition and Importance	25
Strategies for Building Computational Fluency	25
Strategies for Building Fact Fluency	26
SECTION V: PROBLEM SOLVING	28
Strategies for Teaching Word Problem Solving	29
Schema Instruction for Solving Word Problems	31
Additive Schemas	32
Multiplicative Schemas	35
Resources	39
SECTION VI: APPENDICIES	40
Appendix A: Model for Explicit Instruction: Planning Guide	40
Appendix B: Formal Mathematics Language Graphic Organizers	41
Appendix C: Mathematics Instructional Connections for Physical and Visual Representations	43
Appendix D: Fluency Games and Activities	48
Appendix E: Algorithms for Addition, Subtraction, Multiplication, and Division	51
Appendix F: Problem Solving Attack Strategies	57
Appendix G: Comprehensive Overview of Additive Schemas	58
Appendix H: Comprehensive Overview of Multiplicative Schemas	60
SECTION VIII: REFERENCES	62

SECTION I: EXPLICIT INSTRUCTION

DEFINITION OF EXPLICIT INSTRUCTION

Explicit instruction often is described as the cornerstone of effective mathematics instruction for students with learning difficulties (Hudson et al., 2006; Jitendra et al., 2018; Witzel et al., 2003).

Although many helpful models of explicit instruction exist, the model developed by the [National Center on Intensive Intervention](#) (NCII) offers a valuable guide to understanding explicit instruction.

There are three main components of explicit instruction:

- **Modeling:** facilitated by the teacher
- **Practice:** involves the students and the teacher
- **Supports:** consist of an ongoing dialogue between the teacher and students. Supports are employed during modeling and during practice. Supports are described within the explanations of modeling and practice.

See [Appendix A](#) for the *National Center for Intensive Intervention's* model for explicit instruction.

MODELING

Modeling prepares students to complete a mathematics skill successfully. Modeling includes two main components: clear explanations and planned examples.

- **Clear explanations**
 - Provide a 2-3 sentence statement about the goals and importance of the lesson.
 - Explicitly model the steps for solving a mathematical problem.
 - Include important vocabulary and concise mathematics language.
 - Choose to model one example or several examples depending on students' familiarity with the mathematics content.
 - Vary modeling based on students' needs and exposure to mathematical content.
- **Planned examples**
 - Thoughtfully plan examples before the lesson to help students understand the mathematical concept.
 - Ask important questions.

Example for a division lesson:

- *How am I going to present the division problems – using partitive division or measurement division?*
- *Am I going to use a slash, obelus (i.e., \div), long division bracket, or all three symbols?*
- *How many examples do I need to include?*
- Consider examples that are open-ended, worked examples (i.e., previously-solved problems answered correctly or incorrectly), or non-examples.

MODELING

Clear Explanations	Examples
Goals and importance	<p><i>Today we are going to learn about division. Division is important because sometimes you need to share or divide things with your friends, like when you order pizza or want to share candy.</i></p> <p><i>Let's continue working on our three-dimensional shapes. Today, we will learn about cones. Cones are important because we see examples of cones everyday: ice cream cones, party hats, and orange cones in our school parking lot.</i></p>
Explicitly model steps with concise mathematical language (Note: bolded words represent concise mathematical language)	<p><i>To solve 21 plus blank equals 73, I first decide about the operation. Do I add, subtract, multiply or divide?</i></p> <p><i>The plus sign tells me to add, but I know the sum and I am missing one of my addends. So, to find out my missing number, I could count from 21 to 73 or subtract 73 minus 21. I'll subtract 73 minus 21. I'll use the partial differences algorithm. First, I'll subtract 70 minus 20. What's 70 minus 20?</i></p> <p><i>70 minus 20 is 50. I write 50 right here under the equal line. Where do I write the 50?</i></p> <p><i>Then I'll subtract 3 minus 1. What's 3 minus 1?</i></p> <p><i>3 minus 1 is 2. So, I write 2 here in the ones place.</i></p> <p><i>Finally, we add the partial differences: 50 and 2. 50 plus 2 is 52. So, 73 minus 21 equals 52. What's 73 minus 21?</i></p>
Planned Examples	For an addition lesson
Examples	$5 + 6, 9 + 3, 8 + 8$
Worked examples	$5 + 6 = 11; 12 = 9 + 3; 8 + 8 = 16$
Non-examples	$5 \times 6, 9 \div 3, 8 - 8$

SUPPORTS DURING MODELING

Although modeling primarily is teacher-directed, **students actively participate through supports**. During modeling, teachers should attend to the following four supports.

1. Ask high- and low-level questions

While providing clear explanations and presenting planned examples, teachers should ask students a mix of high- and low-level questions. Teachers should aim to ask students a question at least every 30-60 seconds during modeling.

By asking a combination of high- and low-level questions, teachers can evaluate students' understanding and monitor that students are paying attention and on-task. Asking a variety of questions also promotes active engagement in the lesson.

- High-level questions encourage deeper thinking and reasoning and allow teachers to assess

students' conceptual understanding of a mathematics concept.

Example high-level questions:

- How does finding common denominators help us in comparing fractions?
- When is it necessary to regroup when solving a problem? Explain your thinking.
- Low-level questions require simpler answers and are helpful for checking for procedural understanding. The inclusion of low-level questions offers an important way to increase students' participation and minimize frustration. Example low-level questions:
 - *What is 7 times 9?*
 - *What happens when we add 2?*
 - *What operations can we use to solve the word problem?*
 - *Show me an example of a right angle.*

2. Elicit frequent responses

Eliciting frequent responses from students proves essential for maintaining students' attention and determining if lesson components require reteaching or additional planned examples.

Teachers should engage students frequently by eliciting responses at least every 30-60 seconds.

- Students' responses may include answers to high- or low-level questions.
- Students do not need to answer all questions with an oral response.
- Students may respond as a group in a choral or partner response or write or draw an answer on paper, a worksheet, or whiteboard.
- Students can gesture with a thumbs up or thumbs down, use manipulatives, check the work of a problem, or update a vocabulary term on a word wall to convey a response.

When teachers model a lesson, students must participate. Eliciting frequent responses offers an important way to ensure students participate.

The combination of asking questions and eliciting frequent responses often is misunderstood within modeling. Some teachers believe that modeling only consists of teacher demonstration and teacher talk. This is not the case. Effective modeling requires an ongoing dialogue between teachers and students.

3. Provide immediate affirmative and corrective feedback

When students respond to questions during modeling, teachers should provide specific affirmative and corrective feedback. Feedback creates an opportunity to redirect and bolster confidence, both of which are important for students with learning differences, who frequently exhibit low self-esteem and high anxiety related to mathematics. Teachers need to provide feedback to students immediately and as often as possible.

- Affirmative feedback proves most effective when students receive specific comments about concepts or procedures like:
 - *I noticed you used the counting up strategy to add those two numbers.*
 - *I see you are using the geoboard to demonstrate the fraction two-thirds.*
- Corrective feedback is provided by teachers when students make a mistake or misunderstand a concept or procedure. Corrective feedback often involves asking questions and encouraging students to explain their steps and thinking to ensure teachers understand where and why the students have misconceptions about the task and procedures.
 - Pose questions, such as:
 - *Can you explain the steps you followed for this problem?*

- *How did you arrive at 4 for the difference?*
 - Question why students make specific errors to create a learning opportunity for other students by providing confirmation about the steps performed correctly and reviewing the steps needed to correct the mistake.
 - Encourage positive peer interaction and feedback, such as:
 - *Tell your partner how you solved the problem.*
 - *Turn and talk about how you could create a drawing to represent this word problem.*

4. Maintain a brisk pace

During modeling, teachers should maintain a brisk pace. Maintaining a brisk pace requires teachers to plan and organize prior to the lesson.

- Before the lesson, teachers should consider the following questions:
 - *What materials will I need for the lesson?*
 - *In what ways will I incorporate technology?*
 - *Does my seating chart promote optimal student learning and necessary movement during the lesson?*
 - *What planned examples will I use?*
 - *Will I use any worked-examples?*
 - *Will I include any non-examples?*
- Teachers should be knowledgeable about the material and ready to provide effective modeling.
- When teachers maintain a brisk pace, students pay attention and focus on the instruction.
- Planning for the lesson and organizing needed materials ahead of time allow teachers to maintain a brisk pace, which maximizes student learning.

PRACTICE

While modeling *prepares* students to complete the mathematics task successfully, practice provides multiple opportunities for students to *practice* the learned concepts. Practice includes: guided practice and independent practice.

- Guided practice
 - Involves the teacher and students working together to solve a mathematics problem. The teacher solves the problem while students solve the same problem.
 - Takes place at a table, with the teacher and students working a problem together, or the teacher can solve the problem on the whiteboard as students complete the problem at their desks.
 - Allows students to complete a problem for the first time with supports in place to promote understanding of the lesson concept and to encourage students' success.
 - Involves the teacher and students working together using questioning and mathematics tools (e.g., manipulatives, hundreds chart, step-by-step checklist) to guide students through the problem.
 - Involves collaboration among the teacher and students or among groups or pairs of students; however, guided practice is most effective when the teacher works with students to complete a few problems.
 - Helps students with learning difficulties and provides a gradual release of responsibility from modeling to independent practice.

Many teachers include minimal guided practice opportunities or fail to include guided practice in their lessons altogether.

Teachers may model the lesson, then skip directly to independent practice.

Guided practice is essential for supporting students with learning difficulties and should be integral to every mathematics lesson.

- Independent practice
 - Consists of students working independently as the teacher continues to provide feedback and answer questions during completion of the task at hand.
 - Allows the teacher to determine if students understand the concepts and procedures taught during the lesson.
 - Should be implemented under the guidance and supervision of the teacher.
 - Understand that assigning independent practice as homework does not ensure that students are receiving the level of support necessary to understand or solve problems.

SUPPORTS DURING PRACTICE

Effective practice continues the ongoing dialogue between the teacher and students. Ineffective practice encourages students to work independently without teacher support.

- When students are engaged in guided and independent practice, teachers should continue to attend to the four supports:
 - Ask high- and low-level questions
 - Elicit frequent responses
 - Provide immediate affirmative and corrective feedback
 - Maintain a brisk pace
- Explicit instruction involves modeling and practice, with supports embedded into every lesson.
- During introductory lessons, teachers may model several problems and provide a few practice opportunities while asking the right questions, eliciting responses, providing feedback, and maintaining a brisk pace.
- After teachers have introduced the material, they may choose to model one example and offer several practice opportunities for students while attending to the four supports.
- Explicit instruction is flexible and should vary from day to day and lesson to lesson and is based on the individual needs of the student. It should be used in conjunction with other highly effective mathematical practices such as engagement in rich problem solving and mathematical discourse.

Here is an action plan checklist to guide teachers to effectively implement explicit instruction. Ask yourself, *“Does my explicit instruction include these necessary components?”*

- Model steps using concise language
- Provide guided practice opportunities
- Provide independent practice opportunities
- Use supports during modeling and practice
 - Ask the right questions
 - Elicit frequent responses
 - Provide feedback
 - Be planned and organized

RESOURCES

[National Center for Intensive Intervention](#) has several resources related to explicit instruction.

- This [Features of Explicit Instruction Module](#) provides course content focused on enhancing teachers' effective implementation of explicit instruction, including modules on each of the explicit instruction components: modeling, practice, and supports.
- This [Instructional Delivery Module](#) provides mathematics-specific examples related to explicit instruction, along with numerous videos of tutors using explicit instruction with students to teach specific mathematics skills, such as eighth-grade algebra and first-grade addition and subtraction.

SECTION II: FORMAL MATHEMATICAL LANGUAGE

As teachers use explicit instruction to model and provide students with practice, they also need to include formal mathematical language in their instruction. Formal mathematical language refers to the precise mathematical terms used to describe concepts and procedures. Examples of formal mathematical vocabulary terms include *sum*, *digit*, and *numerator*. In contrast, informal mathematical language consists of words like *answer*, *number*, and *top number in the fraction*.

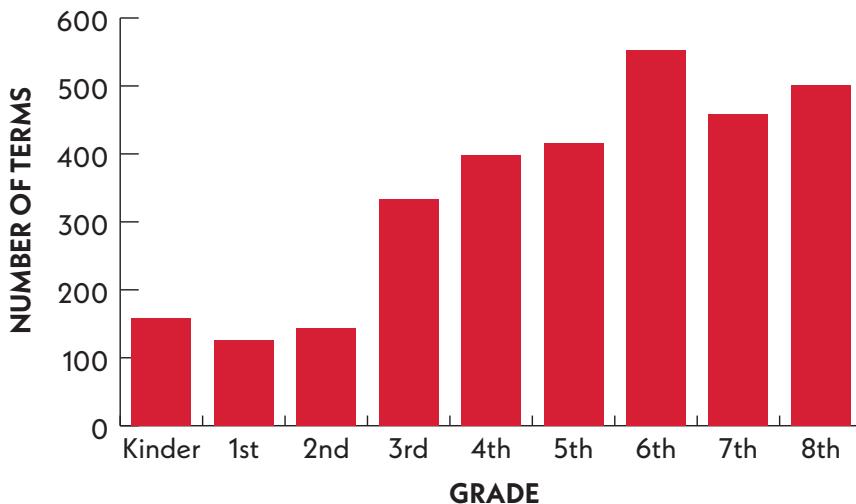

Mathematics vocabulary across grades (Powell et al., 2019).

The above graph *Mathematics Vocabulary across Grades* illustrates the approximate number of formal vocabulary terms in commonly used elementary and middle school mathematics textbook glossaries and depicts the average number of formal mathematics vocabulary terms students are expected to learn at each grade level.

Mathematics vocabulary terms prove challenging for students with learning difficulties for the following seven reasons (Riccomini et al., 2015; Rubenstein & Thompson, 2002):

1. Technical terms

- Mathematics vocabulary includes technical terms, symbols, and diagrams specific to mathematics.
- Most students have never heard or seen the technical terms (e.g., *numerator*, *parallelogram*, *Pythagorean Theorem*).
- Many technical terms may be unfamiliar to students with language-related difficulties, including English Learners (ELs).

Examples:

- The terms *sum*, *value*, and *product* have specific and complex mathematical definitions familiar to most speakers, but new to students with language-related challenges and ELs with limited knowledge of terms (Freeman & Crawford, 2008).
- Symbolic vocabulary terms such as *zero* and *equal* may prove challenging as the symbols used to explain numerals and symbols may be unknown (Powell et al., 2017).

2. Multiple meanings in mathematics and everyday English

- Many mathematics vocabulary terms have multiple meanings in mathematics and English.
- Examples:
 - The word *volume* refers to the amount of space in mathematics but describes a noise level in everyday English.
 - *Cubed* means raised to the third power in mathematics but explains a way to cut vegetables in everyday English.

3. Multiple meanings in mathematics

- Mathematics vocabulary concepts may be represented in multiple ways.
- Mathematics vocabulary concepts may present with multiple mathematical meanings.
- The same word may be used to describe more than one situation.

Examples:

- Over 10 different terms exist to describe subtraction (Moschkovich, 2002).
- A *quarter* may refer to a coin or a fourth of a whole (Moschkovich, 2002).

4. Multiple meanings across academic content areas and contexts

- Many vocabulary terms have multiple meanings across different content areas and in various contexts.

Examples:

- The term *base* can refer to the base of an exponent, the base of a three-dimensional shape, a base versus an acid in chemistry, or the bases in baseball. Students also may think of the homonym *bass*, as in a bass guitarist.

What does the word *degree* mean?

Possible Responses

Angle Deodorant Level
Educational Achievement Temperature

Teachers need to explicitly teach mathematics vocabulary terms like *degree* to help students understand to which definition they are referring.

5. Homonyms

- Some mathematics terms sound the same but have different meanings.

Examples:

- *Sum* and *some* have very different meanings yet sound exactly the same.
- Additional homonyms like *whole/hole*, *half/have*, and *symbol/cymbal* are very confusing when teachers only present the terms orally.

6. Vocabulary terms with multiple words

- Many vocabulary terms that students need to learn include multiple words (e.g., acute angle, rational number, triangular pyramid).
- Students are not only interpreting one word; students are interpreting multiple words and making connections between the words.

- Terms that require knowledge of two words for understanding may cause additional difficulty for students.

7. Similarities to or differences from native language words

- Students with a native language other than English may experience additional challenges with mathematics vocabulary terms due to their similarities and/or difference to their native language words.

Example:

- The Spanish word for *quarter* is *cuarto*, which can mean quarter of an hour, but *quarter* also refers to a room in a house as in living quarters (Roberts & Truxaw, 2013).

FORMAL MATHEMATICS LANGUAGE STRATEGIES

To promote students' understanding of mathematics vocabulary terms, teachers should:

1. Use formal mathematics vocabulary terms

- Teachers should consider the importance of using formal mathematical vocabulary terms (i.e., rather than informal phrases).

Examples:

- Teachers may ask students to solve an equation by writing the *answer*. Even though *answer* is a commonly used term and can be used when students solve a range of equations, the term does not represent the mathematical operations required to solve each equation.
- Using the formal mathematical terms *sum*, *difference*, *product*, or *quotient* reinforces the calculations that students will perform to solve the problems, thus supporting the conceptual understanding of such terms.
- Students will encounter formalized mathematics vocabulary terms in mathematics texts and activities and on high-stakes assessments (e.g., "What is the difference between Teresa's money and Salvador's money?").
- Teachers need to expose students to these terms in preparation for such activities and tests.

Examples:

- On a test question about "Which three shapes are *quadrilaterals*?" if a teacher has not used and practiced the term *quadrilaterals*, it would be difficult for students to answer this question.
- When teaching students to tell time, teachers might refer to a clock as having a *long hand* and *short hand*. This language may hinder students' understanding of clocks because the informal language does little to convey an understanding of telling time. Instead, teachers should use the terms *hour hand* and *minute hand*, and students should use these terms regularly as well.
- To ensure students understand the formal mathematical language needed to solve problems and develop solutions, teachers need to explicitly teach mathematics vocabulary terms through the context of the problems being presented.

2. Use similar or related terms correctly and precisely

- Teachers need to be correct, precise, and specific when using closely related mathematical terms (Powell et al., 2018).

Example:

- Teachers may use the terms *factor* and *multiple* interchangeably, but these terms have

distinct meanings. Using these terms interchangeably may cause confusion for students. The term *factor* refers to all of the whole numbers by which you can divide a number with no remainder (e.g., the factors of 6 are 1, 2, 3, and 6), but the term *multiple* refers to the number after multiplying 6 by another whole number (e.g., 6, 12, and 18 are multiples of 6). Each number has a fixed number of *factors* (i.e., there are four factors for the number 6), but many possible *multiples* (e.g., $6 \times 1 = 6$, $6 \times 2 = 12$, $6 \times 3 = 18$, etc.).

- During lesson planning, teachers should reflect on which formal vocabulary terms to explicitly teach to students through the context of the problems being presented.
- Teachers should consider any technical, sub-technical, symbolic, and/or general terms related to the lesson content.
 - Technical terms, or vocabulary words with a specific mathematical meaning, should be explicitly taught to students.
 - Sub-technical terms include multiple meanings, at least one of which is related to mathematics. Teachers should think about students' exposure to sub-technical terms to determine which terms need to be explicitly taught in the lesson.
 - For example, *square* can describe a shape or a location, such as a town square. Students may also square a number (5^2).
 - Teachers may want to engage students in discrimination or sorting activities with a term that has several meanings or with several terms that share similar meanings.
 - Teachers should consider symbolic terms, which are the terms used in math to represent symbols.
 - For example, students might be able to write \$, but unable to read the word *dollar*.
 - Understanding symbolic terms is essential when students are asked to read and interpret word problems.
 - General terms are frequently integrated into mathematics instruction.

Example questions for teachers to consider:

- Do students know what it means to *measure* something?
- Do students understand how to find the *longest* length or identify the shape located *above*?
- For students with mathematics-learning difficulties, language can create an additional challenge.
- Teachers' selection of terms should directly align with students' language skills, knowledge, and familiarity with the mathematics content.

Why does language present a challenge for students with mathematics difficulty?

- Comorbidity rates, or students identified with at least two disabilities, range between 30-70%.
- In many cases, students with mathematics learning disability or difficulty also experience reading difficulties.
- Let's consider a teacher is working with a small group of 4 students. Researchers estimate at least 2 of the 4 students will have comorbid reading and mathematics challenges.

3. Plan for language use prior to instruction

- Teachers should consider their language use (as well as students' language use) prior to instruction.
- In many cases, teachers limit the mathematical language used within intervention or instruction. Teachers also may try to make the language easier for students (i.e., use informal language instead of formal language). Using limited or informal language does not prepare students for success.

- Students are exposed to formal mathematical language in their mathematics textbooks, on assessments, and in online mathematics videos. Teachers should present the same formal mathematical language during instruction to support students' long-term learning and mathematical understanding.
- Teachers may need to engage students in activities where they define similar terms (e.g., parallelogram, trapezoid, rhombus, rectangle, square, and kite) and describe how the terms are similar or different. During these explanations, teachers need to be specific and precise.

4. Include explicit vocabulary activities in instruction

- Teachers should include explicit vocabulary activities in their instruction to ensure students actively practice using vocabulary terms essential for understanding mathematics concepts.
- Instead of informally exposing students to mathematics vocabulary, teachers should directly teach vocabulary and provide meaningful practice opportunities for students (Riccomini et al., 2015).
 - During explicit instruction of vocabulary terms, teachers and students can co-create concept maps, develop word walls, and encourage students to maintain individual dictionaries of mathematical terms.
 - Teachers are encouraged to use [Virginia's Mathematics Vocabulary Word Wall Cards](#) for reference.
- Teachers also may consider limited utilization of mnemonic devices to improve students' understanding of terms and access prior knowledge.
- Multiple exposure to mathematics terms that build fluency are essential for developing students' mathematical vocabulary competency.
 - The use of flashcards (with the word on one side of the index card and the definition and a picture on the other side) and game-like activities offer useful ways to reinforce previously introduced mathematics vocabulary during instruction.
 - Teachers can use flashcards as fluency builders during instruction, as a transition game as students wait in a line, or as an exit slip that requires students to describe a vocabulary word before exiting the classroom.
 - Students may add their vocabulary cards to a ring and practice throughout the school day.
 - Vocabulary game-like activities also increase students' motivation and learning.
 - *Word-O* is an adapted form of Bingo and *Word Sorts* allow students to categorize, compare, and contrast words.
 - For a more extensive list and explanations of popular vocabulary games, visit the [Flocabulary](#) website. (Riccomini et al., 2015).

5. Hold students accountable

- Teachers should hold students accountable for using formal mathematical language correctly.
- In addition to listening to the language of mathematics, teachers need to create opportunities for students to speak about mathematics and write about mathematics using formal mathematical language.
 - Some students go through an entire mathematics lesson without speaking the formal language of mathematics.
 - Without practice listening, speaking, writing, and reading in mathematics, students will not develop a strong lexicon of mathematical language.
 - Most mathematics content is disseminated through oral listening (i.e., listening to teachers or peers talking about mathematics) and reading (i.e., reading text online or in a textbook), whereas most learning occurs through speaking and writing.
 - To maximize students' learning, teachers must focus on the mathematics concepts and procedures; language is an essential component of this learning.

To develop an action plan for successful learning of formal mathematical language, teachers should consider referencing the “Instead of that, Say this” graphic organizers. “Instead of that, Say this” supports teachers in their efforts to translate informal mathematical language to formal and precise mathematical language.

“Instead of that” refers to the informal mathematical language terms that do little to prepare students to develop a conceptual understanding of mathematics content.

“Say this” refers to the formal mathematical language teachers should include in their instructional practices.

For example, instead of saying “reduce the fraction,” say “find the equivalent fraction” so that students don’t have the misconception that the magnitude of the value will be less.

See [Appendix B](#) for several examples of “Instead of That”, “Say this” Graphic Organizers.

SECTION III: CONCRETE, REPRESENTATIONAL, AND ABSTRACT CONNECTIONS

CONCRETE, REPRESENTATIONAL, AND ABSTRACT CONNECTIONS

The concrete-representational-abstract (C-R-A) sequence is an evidence-based practice supported by research (e.g., Flores et al., 2014; Witzel et al., 2008). In this Resource Guide, C-R-A is presented as a framework in which the concrete, representational (pictorial), and abstract forms of mathematics work collaboratively to facilitate students' deeper understanding of mathematics concepts.

The C-R-A framework, displayed below, considers the diverse needs of students with learning difficulties by utilizing supports when necessary. That is, students with learning difficulties require varied levels of support; some students may require more practice with concrete forms while other students may benefit from a combination of concrete and pictorial supports to access the abstract. Viewed as a framework, students are better able to generalize their conceptual knowledge from the representational and concrete understandings to the abstract (Peltier & Vannest, 2018). Additionally, it is important for teachers to make explicit connections between all three levels of the understanding (Strickland & Maccini, 2013).

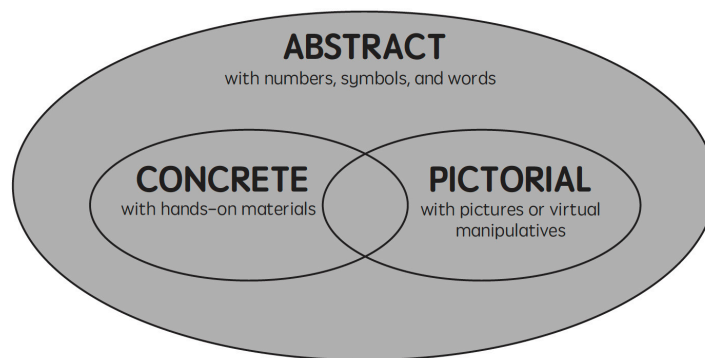

Concrete-Representational-Abstract framework

This framework includes three forms of mathematics: concrete, representational (pictorial), and abstract.

1. Concrete form

- Refers to the three-dimensional, hands-on materials and objects that students can touch and move to promote understanding of different concepts and procedures.
- Includes hands-on formal manipulatives such as fraction bars, algebra tiles, tangrams, geoboards, and two-color counters
- Includes hands-on manipulatives that are less formal (e.g., straws for measurement, paper clips for place value, or shoeboxes for three-dimensional figures).

2. Representational (Pictorial) form

- Includes two-dimensional pictures, images, or virtual manipulatives.
- In many cases, the pictorial is referred to as the semi-concrete or representational. As the abstract, concrete, and pictorial are considered representations of mathematics, the term pictorial is used to describe the third component of the multiple representations framework.
- Pictorial images may be presented within textbooks or workbooks, in teacher and student drawings, and on high-stakes standardized assessments.
- The pictorial form includes graphic organizers that help students understand mathematics concepts (e.g., Jitendra & Star, 2012).

- The pictorial may be presented in the form of technology through the use of virtual manipulatives.
 - For every hands-on manipulative, a corresponding virtual manipulative exists. Many of these virtual manipulatives are free or provided at little cost.

3. Abstract form

- Consists of numbers, symbols, and words, and reflects the typical view of mathematics (e.g., $42 + 102 = 144$).
- In many cases, the abstract form of mathematics is students' destination, but teachers use the concrete and pictorial representations to support students' understanding of abstract concepts and procedures.

THE BENEFITS OF C-R-A CONNECTIONS

- Presenting mathematics content in many ways promotes understanding of abstract concepts for all students, especially those with mathematics difficulty.
- Together, the concrete and pictorial forms support the explanations of abstract concepts and procedures.
- When using the concrete or the pictorial, teachers should display and discuss the abstract form of a problem.

Example:

- If teachers use two-color counters to show the fraction two-thirds, they also need to write the fraction on the board.
- When learning about the relationship between fractions and decimals, students may use a digital or concrete geoboard to understand the connection.
- During this lesson, teachers also should display the abstract form of the fraction and decimal (e.g., $\frac{2}{3}$ is the same as 0.60).
- The use of C-R-A supports students developing a deeper conceptual understanding of mathematics beyond superficial procedural knowledge.
- Evidence shows that some students may need more practice with concrete or pictorial materials, whereas other students may benefit from more practice with abstract forms.
- Teachers need to remain flexible with their use of C-R-A to address the unique and diverse needs of students with disabilities.
- As students develop a conceptual understanding of the content, they often transition from concrete and pictorial representations to more abstract representations.
- Teachers must provide C-R-A with explicit instruction to explain and practice with the representations (van Garderen et al, 2012).

The charts on the next page further illustrates the benefit of using C-R-A. The charts compares teaching a mathematics concept with manipulatives versus without manipulatives. Specifically, the first example focuses on teaching middle and high school students to understand quadratic expressions, and the second example focuses on teaching elementary students to understand addition using the partial sums strategy.

The charts demonstrates that the simultaneous presentation of abstract, concrete, and pictorial forms of mathematics supports students with disabilities above and beyond the abstract presentation alone. At any grade level, the use of manipulatives benefits students in their development of conceptual understanding and procedural knowledge.

WITH MANIPULATIVES

Lesson Objective:

Using x-rods, students will represent and sketch rectangle area problems involving linear expressions containing only positive terms to produce a quadratic expression.

- Students participate in an introductory lesson to multiply two binomial expressions using manipulatives as a visual aid/tool to represent quantity. The yellow units are used to represent integer constants; the long blue rods represent the variable x . The square blue flats represent x^2 .

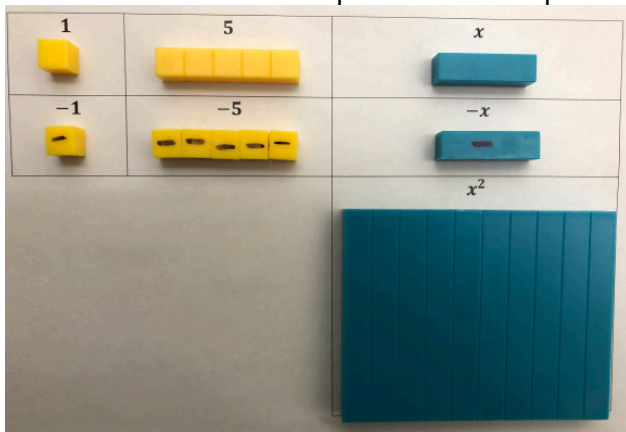

- Students will utilize the manipulatives to demonstrate how they are manipulating the blocks to multiply the binomial expressions.
- The teacher demonstrates how to use the manipulatives when multiplying linear expressions. The teacher emphasizes the distributive property using the corner piece and manipulatives.
- Students multiply the linear expressions with manipulatives to complete the table below. They also sketch the manipulatives and write an equation in the form of the area formula for rectangles (length \cdot width = area). The students use concrete manipulatives, sketched representations of the manipulatives, and abstract symbols such as variables and constants.

We all have a square shaped rec room where we like to hang out with our friends. We would like to buy a ping pong table but will need to expand all of our basements so that the length is increased by 4 feet and the width is increased by 2 feet. Fill in the table below.

	Side of original rec room in feet	New length in Feet	New width in feet	New Area in square feet
Amy	9	$9+4=13$	$9+2=11$	$13 \cdot 11=143$
Shanla	10	$10+4=14$	$10+2=12$	$14 \cdot 12=168$
Delsa	11	$11+4=15$	$11+2=13$	$15 \cdot 13=195$
Any square rec room	x	$x+4$	$x+2$	$(x+4)(x+2)$

WITHOUT MANIPULATIVES

Lesson Objective:

Students will learn how to multiply binomials to create a quadratic expression.

- Students learn about quadratic expressions.
 - The teacher demonstrates how to multiply two binomials, such as $(x + 4)(x + 2)$. The teacher discusses multiplication using the distributive property and shows how to multiply $x \cdot x$, then $x \cdot 2$, then $x \cdot 4$, then $4 \cdot 2$.
- The teacher discusses simplifying $x^2 + 4x + 2x + 8$ which simplifies to $x^2 + 6x + 8$.
- The students work a problem on their own.

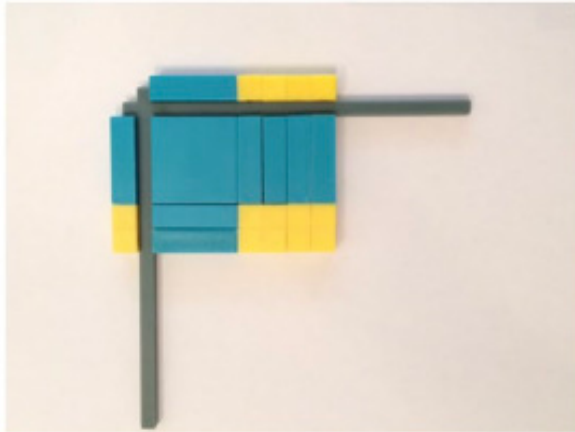

Write area equation: length • width = area $(x+4)(x+2) = x^2 + 6x + 8$

What happened to the area of the bedroom? *It became bigger*

What about the shape? *Changed from a square to a rectangle*

How does the shape of the tiles compare to your drawings of

Our renovated rec rooms? *same*

In the problem above $(x + 4)(x + 2)$, the first x -rod on the top of the corner piece is multiplied by the x -rod on the side of the corner piece to equal x^2 , which is inside the corner piece.

Second, the x -rod on the side of the corner piece is multiplied by the four yellow units on the top. This equals four x -rods that are placed inside the corner piece to the right of the x^2 flat and directly under the four yellow units on the top of the corner piece.

Third, the two yellow units on the side of the corner piece are multiplied by the x -rods on the top of the corner piece. This equals two x -rods, which are placed inside the corner piece under the x^2 flat.

Last, the four yellow units on the top of the corner piece are multiplied by the two yellow units on the side to equal 8 yellow units inside the corner piece to complete the rectangle. This translates to the quadratic expression of $x^2 + 4x + 2x + 8$ which simplifies to $x^2 + 6x + 8$.

Teaching multiple linear quadratic expressions with and without manipulatives (Strickland, 2017)

WITH MANIPULATIVES

WITHOUT MANIPULATIVES

Lesson Objective:

Using Base-10 blocks, students will learn how to solve two-digit problems using the partial sums strategy.

Lesson Objective:

Students will learn how to solve two-digit problems using the partial sums strategy.

1. Students participate in an introductory lesson to solve two-digit problems using manipulatives as a visual aid/tool to represent quantity. The green rods represent tens; the green units represent ones. The teacher asks students what they recall about addition or what it means to add. Responses will likely include ideas such as addition is putting together or adding on. In an introduction to the Base-10 blocks, students recognize that the green rod represents ten of the unit cubes.

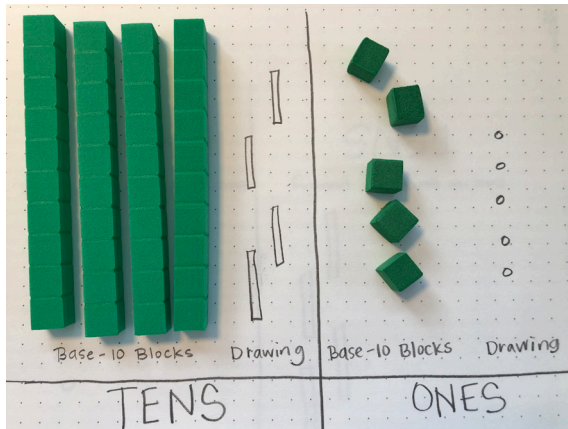

2. Students will utilize the manipulatives to demonstrate how they are solving the problem using the partial sums strategy. The students will add the tens for a partial sum by moving the rods together. The students will add the ones for a partial sum by moving the ones together.
3. The teacher demonstrates how to use the manipulatives when adding using the partial sums strategy. The teacher emphasizes the adding the tens then adding the ones, and the shows how to add the partial sums by counting all the rods and all the units.
4. Students add with manipulatives to complete the problem. Students also sketch the manipulatives. The students use concrete manipulatives, sketched representations of the manipulatives, and abstract symbols.

1. Students learn about the partial sums strategy in which students will add the tens then add the ones.
2. The teacher demonstrates how to solve a problem, such as 45 plus 23. The teacher describes adding the tens: 40 plus 20 to equal 60. The teacher writes 60.
3. The teacher describes adding the ones: 5 plus 3 to equal 8. The teacher writes 8.
4. The teacher shows adding 60 plus 8 for a sum of 68. The teacher writes 68.
5. The students work a problem on their own.

WITH MANIPULATIVES

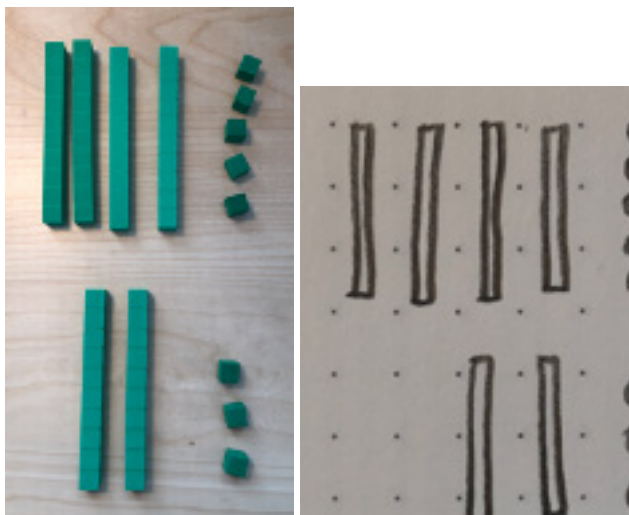

$$\begin{array}{r}
 45 \\
 + 23 \\
 \hline
 60 \\
 + 8 \\
 \hline
 68
 \end{array}$$

WITHOUT MANIPULATIVES

In the problem above ($45 + 23$), the student shows or draws 45 as 4 rods and 5 units. The student shows or draws 23 as 2 rods and 3 units. The student sets up the manipulatives or drawing similar to the abstract form of the problem – with one addend placed on top of the other addend.

The student adds the tens (green rods) together to equal 60.

Then, the student adds the ones (green units) together to equal 8.

The student adds 60 plus 8 for a sum of 68. 45 plus 23 equals 68.

Teaching Addition Using Partial Sums with and without Manipulatives

When developing a C-R-A action plan for successful learning, teachers may wish to reference the chart in [Appendix C](#) from the Virginia Department of Education that includes mathematics instructional content connections for concrete and pictorial representations. Teachers also require access to helpful manipulatives.

RESOURCES

Virtual Manipulatives

- [National Library of Virtual Manipulatives](#)
- [Toy Theater Virtual Manipulatives](#)
- [Math Playground Virtual Manipulatives](#)
- [Math Learning Center Free Apps](#)
- [Geogebra](#)

Project STAIR (Supporting Teaching of Algebra: Individual Readiness) YouTube channel

- The links below provide examples for how to multiply linear expressions using a variety of manipulatives and graphic organizers within contextualized problems.
 - [Multiplying Linear Expressions – Part 1 – Using Algebra Blocks](#)
 - [Multiplying Linear Expressions – Part 2 – Multiplying Positive Terms](#)
 - [Multiplying Linear Expressions – Part 3 – Multiplying Positive and Negative Terms](#)
 - [Multiplying Linear Expressions – Part 4 – Graphic Organizers and Contextualized Problems](#)

National Center for Intensive Intervention

- [Teach Counting Using Manipulatives Video](#)
- [Manipulatives to Illustrate Basic Facts: Addition Problem Structures Video](#)
- [Represent Place Value Concepts with Base-10 blocks Video](#)
- [Manipulatives to Convert Improper Fractions to Mixed Numbers Video](#)

SECTION IV: FACT AND COMPUTATIONAL FLUENCY

DEFINITION AND IMPORTANCE

The *2016 Mathematics Virginia Standards of Learning Curriculum Framework* describes computational fluency as developing flexible, efficient, and accurate methods for computing. A student exhibit computational fluency when they demonstrate strategic thinking and flexibility in the computational methods they choose, are able to explain, and that produce accurate answers efficiently.

The computational methods used by a student should directly align with the mathematical ideas that the student understands, including the structure of the base-ten number system, number relationships, meaning of operations, and properties.

Computational fluency with whole numbers is a goal of mathematics instruction in the elementary grades and builds the foundation for later mathematics concepts. Students should be fluent with the basic number combinations for addition and subtraction to 20 by the end of Grade 2 and those for multiplication and division by the end of Grade 4. Teachers should encourage students to use computational methods and tools that are appropriate for the context and purpose.

STRATEGIES FOR BUILDING COMPUTATIONAL FLUENCY

Computational fluency is the ability to think flexibly in order to choose appropriate strategies to solve problems accurately and efficiently. Flexible thinking strategies can be used to develop computational fluency with basic facts and can then be expanded to use with larger numbers.

Beyond basic facts, students should develop fluency with computation (i.e., multi-digit addition, subtraction, multiplication, or division).

- Teachers can use explicit instruction to model and practice different computational algorithms.

For Example:

- When teaching multi-digit addition, teachers should demonstrate two or more of the following algorithms across a number of weeks:
 - Traditional (work right to left)
 - Partial sums (work left to right)
 - Opposite change (round one number to the nearest ten; amount added is subtracted from the other number)
 - Column addition (work left to right).
- Students should share their ideas collaboratively with how to solve problems in different ways and then choose a strategy that they understand, can explain, and produces accurate answers efficiently.

See [Appendix E](#) for some examples of algorithms and associated visual models for addition, subtraction, multiplication, and division.

To develop fluency with whole-number computation and rational-number computation, students must have ongoing, spaced practice opportunities. Teachers should introduce different algorithms for solving multi-digit problems and allow students to choose the method that works best for them. With computational fluency, memorization is not the goal but rather the development of efficiency and flexibility with computational procedures. Ultimately, teachers should consider embedding fluency activities into instruction when teaching any mathematics topic or concept.

STRATEGIES FOR BUILDING FACT FLUENCY

- Fluency practice is an evidence-based strategy for supporting students with mathematics difficulty. Students with learning difficulties should be provided brief daily opportunities for fact practice as needed and include numeracy routines. Facts can and should be practiced in a variety of ways (i.e., using a variety of games, activities, songs, and worksheets). Students need practice in the use and selection of efficient strategies.

STRATEGIES FOR DEVELOPING ADDITION AND SUBTRACTION BASIC FACTS

STRATEGY	EXAMPLE
Use Counting on/Counting Back	$5 + 3 = 8$ (Students counts on from 5 to reach 8) $6 - 4 = 2$ (Students count back from 6 to reach 2)
Use One More Than/Two More Than; One Less Than/Two Less Than	$1 + 1$; $2 + 1$; $3 + 1$ or $1 + 2$; $2 + 2$; $3 + 2$ $9 - 1$; $8 - 1$; $7 - 1$ or $9 - 2$; $8 - 2$; $7 - 2$
Use Doubles/Near Doubles	$2 + 2$; $3 + 3$; or $3 + 4 = (3 + 3) + 1$; $6 + 7 = (6 + 6) + 1$
Make 10 Facts	$7 + 4 = (7 + 3) + 1 = 11$; $5 + 8 = (5 + 5) + 3 = 13$
Think Addition for Subtraction	For $9 - 5$, think "5 and what number makes 9?"
Use of the Commutative Property	$4 + 3$ has the same value as $3 + 4$
Use of Related Facts	$4 + 3 = 7$, $3 + 4 = 7$, $7 - 4 = 3$, and $7 - 3 = 4$
Use of the Additive Identity Property	$4 + 0 = 4$; $9 + 0 = 9$
Use Patterns to Determine Sums	$0 + 5 = 5$, $1 + 4 = 5$, $2 + 3 = 5$, etc.

The development of computational fluency, as it relates to working with larger whole numbers, relies on quick access to number facts. The patterns and relationships that exist within the multiplication and division facts are helpful in learning and retaining fact fluency. Studying the patterns and relationships provides students the opportunity to build a foundation for fluency with multiplication and division facts.

STRATEGIES FOR DEVELOPING MULTIPLICATION AND DIVISION BASIC FACTS

STRATEGY	EXAMPLE
Use Skip Counting	Students count by multiples of a number; $5, 10, 15, 20, 25 = 5 \times 5$
Use Doubles	Students know that doubling a number is the same as multiplying by 2; $7 \times 2 = 7 + 7$; $6 \times 2 = 6 + 6$
Use Foundational Facts to Derive Unknown Facts	Decomposing one of the factors in 7×6 , allows for the use of the foundational facts of 5s and 2s. This knowledge can be combined to learn the facts for 7 (e.g., 7×6 can be thought of as $(5 \times 6) + (2 \times 6)$)
Derive Unknown Facts	Deriving unknown facts from known facts may include: doubles (2s facts), doubling twice (4s facts), five facts (half of ten), decomposing into known facts (e.g., 7×8 can be thought of as $(5 \times 8) + (2 \times 8)$).
Use Properties of the Operations	commutative property ($5 \times 8 = 8 \times 5$); distributive property of multiplication allows students to find the answer to a problem such as 6×7 by decomposing 7 into 3 and 4 (e.g., $6 \times 7 = 6 \times (3 + 4)$) allowing them to think about $(6 \times 3) + (6 \times 4) = 18 + 24 = 42$
Think Multiplication for Division	For $30 \div 5$, think "5 times what number equals 30?"
Use of Related Facts	$6 \times 3 = 18$, $3 \times 6 = 18$, $18 \div 3 = 6$, and $18 \div 6 = 3$
Use of the Multiplicative Identity Property	$4 \times 1 = 4$; $10 \times 1 = 10$; $1 \times 22 = 22$

Strategies for solving problems that involve multiplication or division may include mental strategies, the use of place value (i.e., partial products, the standard algorithm) and the properties of the operations (i.e., commutative, associative, multiplicative identity, and distributive, etc.).

When practicing facts, students may benefit from opportunities to individually graph their scores, as age-appropriate, related to fact knowledge in order to track how their fluency is progressing.

Technology can serve as a valuable tool for developing students' fluency skills. Prior to choosing a fluency game or activity, teachers should select a game or activity that will:

- provide practice with small sets of facts;
- track and allow students' to monitor their progress; and
- provide feedback to students (particularly when students make errors).

Fact fluency can be developed in a variety of ways. [Appendix D](#) provides examples of fluency-related games and activities that can be utilized to help students improve their fluency skills. During any fluency game or activity, students should practice small sets of facts that include known and unknown facts. Additional game ideas can be also be found at [You Cubed](#).

SECTION V: PROBLEM SOLVING

Teaching problem solving strategies is an essential evidence-based strategy for supporting students with mathematics difficulty. The focus of this section is effective instruction related to problem solving. Problem solving provides an opportunity for students to demonstrate mathematics competency, yet often proves challenging for students with learning difficulties.

As stated in the 2016 Virginia Mathematics Curriculum Framework, becoming a mathematical problem solver represents one of the five mathematics process goals. To become a mathematical problem solver, students must apply mathematical concepts and skills and understand the relationships among them to solve problems of varying complexities.

Students also must recognize and create problems from real-world data and situations within and outside mathematics and apply appropriate strategies to determine acceptable solutions. To accomplish this goal, students need to develop a set of skills and strategies for solving a range of problems.

To assess a student's problem-solving skills, word problems are often presented. A word problem (see below for a sample) is a scenario presented with words and numbers that requires students to interpret the prompt or question and provide a response. Word problems are often challenging for students with learning difficulties.

- Because reading, language, and the concepts and procedures of mathematics serve as prerequisite skills for understanding word problems, many students, especially those with learning difficulties, experience challenges when solving word problems (Jitendra & Star, 2011; Krawec et al., 2012; Xin et al., 2005).
- For students with learning difficulties, there are seven areas where students experience difficulty with word-problem solving: reading the problems, understanding vocabulary, identifying relevant information, interpreting charts and graphs, identifying the appropriate operation(s), and performing the computation(s).

Students solve word problems that typically fall into three different categories:

- 1. Directive word problems**
 - Students are provided directions to complete a task or find missing information.
 - Directive problems are usually not contextualized.
- 2. Routine word problems**
 - Present numbers within the problem (or within a chart or graph).
 - Include a word-problem prompt or question that encourages students to manipulate the numbers to find the answer.
 - May involve one or two steps.
- 3. Non-routine word problems.**
 - Usually include multiple solutions or multiple ways to solve the problem.

The chart on the next page provides examples of each type of word problem.

DIRECTIVE	ROUTINE	NON-ROUTINE
Which expressions are equivalent to $3(2x-2y)$?	A brownie recipe requires cup of sugar. How many batches can be made with cups of sugar?	The Pencil Company sells pencils in the following quantities: <ul style="list-style-type: none"> Singles (1 pencil) Bundles (10 pencils) Boxes (100 pencils) Cases (1,000 pencils)
Rotate the shape 90 degrees counter-clockwise around the origin.	On July 1, the value of a stock was \$37.40. On July 31, the value of the stock changed by a gain of \$12.75. What was the value of the stock at the end of July?	The Pencil Company just received an order for 2,342 pencils. However, they currently have only one case of pencils in stock, but they have a large quantity of the other packing sizes. Show at least three different ways that the pencils could be packed for this order. Explain your thinking using pictures, numbers, and words.



Examples of directive, routine, and non-routine word problem

STRATEGIES FOR TEACHING WORD PROBLEM SOLVING

Because of the importance placed on problem solving within elementary, middle, and high school, a strong research base exists to help teachers understand how to provide effective word-problem instruction.

- First, students need to learn an attack strategy to help guide the process of problem solving (Jitendra & Star, 2012; Montague, 2008; Xin & Zhang, 2009).
- Second, students need to recognize and solve word problems according to the schema of the word problem (Jitendra et al., 2002; Jitendra & Star, 2012; Van de Walle et al., 2013; Xin & Zhang, 2009).
- As part of appropriate schema instruction, teachers need to use appropriate mathematical language to help students understand the meaning of each word problem.
- Teachers should consider the following three points displayed in the figure below when teaching students with learning difficulties to solve problems.

DOS AND DON'TS FOR TEACHING PROBLEM SOLVING.

 <p>DON'T tie key words to operations.</p>	 <p>DO have an attack strategy.</p>	 <p>DO teach word-problem schemas.</p>
--	---	--

1. DON'T tie key words to operations.

- Teaching key words as a strategy for solving problems is an ineffective practice.
- When key words are tied to operations, students play seek and find with word problems. That is, students look for a key word and then use the operation signaled by the key word without thinking conceptually about what the problem is asking.
- In problem solving, emphasis should be placed on thinking and reasoning rather than on key words. Focusing on key words such as in all, altogether, difference, etc., encourages students to perform a particular operation rather than make sense of the context of the problem. A key-word focus prepares students to solve a limited set of problems and often leads to incorrect solutions as well as challenges in upcoming grades and courses.
- From a teaching perspective, it does not make sense to teach students a strategy (e.g., key words tied to operations) that leads to incorrect responses.

Examples:

- Students often interpret *share* as a term that means division.
- *Share* works as a division term in: *Nevaeh wants to share 36 brownies with 6 friends. How many cookies will each friend receive?*
- *Share* does NOT work as a division term in: *Nevaeh baked 36 brownies and shared 16 brownies with her friends. How many brownies does Cynthia have now?*
- Teachers should avoid defining word problems by the operation. Activities that label the operation (e.g., Division Problems) prove especially problematic because students may solve problems in different ways.
- Neither tying key words to operations nor defining word problems by the operation have an evidence base to support their use.

2. DO make sure students have an attack strategy.

- An attack strategy serves as a tool that students can use to structure their thinking before and during the solving of a word problem.
- An attack strategy is grounded in metacognitive strategies and commonly uses a mnemonic and/or acronym to prompt students' recall.
- An attack strategy often includes self-regulation components, whereby students ask themselves questions and monitor their performance as they solve a word problem.
- An attack strategy generally follows the outline of problem solving from George Pólya (1945):
 - Understand
 - Plan
 - Carry out
 - Look back
- Teachers should confirm that the first step in the attack strategy is to read the problem.
- Teachers can use their preferred attack strategy with students (and students only need one).
- Regardless of the selected attack strategy, students should use the same attack strategy when solving every word problem.
- A frequently used attack strategy is called UPS Check. Students follow a set of explicit steps for setting up the word problem by being asked to:
 - Understand: involves a careful reading of the problem and asking, "What is the problem mostly talking about?"
 - Plan: includes a focus on the underlying schema of the word problem (see next section below).
 - Solve: involves solving the problem using a computational strategy of the student's choosing.
 - Check the answer: includes using self-regulation skills to ask, "Does this answer make sense and why?"

- With any attack strategy, students need explicit instruction (i.e., teaching with modeling and practice opportunities) to learn how to apply the attack strategy to different word problems.
- When problem solving is the focus of instruction, attack strategies must be modeled regularly and practiced by the students.
- An attack strategy poster displayed on the wall of the classroom only proves helpful when teachers refer to the poster and students utilize the attack strategy.
- At some point, some students rely less on the attack strategy as the problem-solving process becomes ingrained. However, teachers should model the use of an attack strategy until students understand and routinely use the attack strategy independently when solving word problems.

See [Appendix F](#) for sample attack strategies that are useable across the elementary and middle school grades.

3. DO Teach word-problem schemas:

Once students learn an attack strategy, the next step is to teach students to understand word problems according to their schema, or problem structure.

- A schema is a framework for solving a word problem (Powell, 2011). In schema instruction, students are taught to recognize a given word problem as belonging to a schema (i.e., problem type) and employ strategies to solve that word-problem type.
- Almost all routine word problems that students see and solve in elementary and middle school fall into one of six different schemas:
 - Total
 - Difference
 - Change
 - Equal Groups
 - Comparison
 - Ratios or Proportions

SCHEMA INSTRUCTION FOR SOLVING WORD PROBLEMS

Research on schema instruction has highlighted the benefit of teaching this strategy to students (Fuchs, et al., 2004; Fuchs et al., 2008; Jitendra et al., 2007). Many students with learning difficulties have trouble setting up and solving word problems. Students experience challenges when identifying the relevant information necessary for solving the problem (Krawec, 2014) and when selecting the operation to use for computation or performing the computation (Kingsdorf & Krawec, 2014). To alleviate these difficulties, teachers can help students focus on the underlying schema of a word problem and provide practice identifying relevant information, using graphic organizers to organize important information, and solving the problems.

ADDITIVE SCHEMAS

- The three additive word-problem schemas include Total, Difference, and Change problems.
- Additive schemas involve word problems in which addition or subtraction may be used for solving the problem. The operation, however, does not define the word problem – the schema defines the word problem.

1. Total problems

- In Total problems, two or more separate parts combined for a sum or total (Kintsch & Greeno, 1985; Fuchs et al., 2014).
- Total problems may be referred to as Combine or Part-Part-Whole problems. In the [2016 Virginia Standards of Learning Curriculum Framework](#), this problem type is referred to as Part-Part-Whole.
- Total problems require an understanding of part-part-whole relationships (i.e., the whole is equal to the sum of the parts; Jitendra et al., 2007).
- In Total problems, the unknown may be the total or one of the parts.
- After determining that a word problem adheres to the Total schema, students can use a graphic organizer to organize the word-problem information.
- Determining how to apply the numbers from the word problem and use the numbers appropriately often proves difficult for students with learning difficulties; therefore, a graphic organizer makes this task easier.
- Total problems also may include more than two parts, which requires an adjustment to the graphic organizer.
- The figure below shows a worked example of a Total problem.
 - The student used the UPS Check attack strategy to set up and solve the word problem.
 - The student underlined the focus of the problem (i.e., cookies).
 - The student determined that there was no irrelevant information; all of the numbers referenced cookies.
 - The student decided this problem was a Total problem because the statement asked about the total number of cookies Meghan baked in all. The student used the graphic organizer to organize the numbers from the word problem.
 - The student identified one part as 28 and one part as 24.
 - The student used a question mark to represent the unknown. In this example, the unknown was the total.
 - The student added to determine the total was 52.
 - The student wrote a label, cookies, for the number answer and checked to make sure the answer made sense (i.e., the sum was greater than both addends).

Sample Total problem:

Megan baked 28 sugar cookies and 24 chocolate chip cookies. Enter the total number of cookies Megan baked in all.

?	
(total)	
24	28
(part)	(part)

Total = 52 cookies

2. Difference problems

- In Difference problems, students compare an amount that is greater and an amount that is less to find the difference.
- The unknown may be the amount that is greater, the amount that is less, or the difference.
- Difference problems also may be referred to as Compare problems, as they are referred to in the 2016 Virginia Standards of Learning Curriculum Framework.
- Students may use a graphic organizer to solve difference problems.
- The figure on the following page shows a worked example of a Difference problem.
 - The student used the UPS Check attack strategy to set up and solve the word problem.
 - The student underlined the focus of the problem (i.e., wooden beads and glass beads).
 - The student determined that there was no irrelevant information; all of the numbers referenced beads.
 - The student determined the problem was a Difference problem because the problem was comparing Jana's wooden beads to Jana's glass beads to find the difference.
 - The student used a graphic organizer to organize the numbers from the word problem.
 - The student identified Greater as 107 and Less as 68.
 - The student used a question mark to mark the unknown. In this example, the unknown was the difference.
 - The student subtracted to determine the difference was 39.
 - The student wrote a label, (more) beads, for the number answer and checked to make sure the answer made sense (i.e., the minuend was greater than the subtrahend and difference).

Sample Difference problem

Jana has 107 wooden beans and 68 glass beads. How many more wooden beads than glass beads does Jana have?

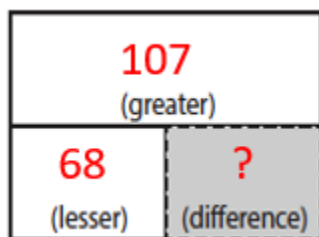

Difference = 39 Beads

3. Change problems

- Change problems usually begin with an initial quantity and something happens to increase or decrease that quantity.
- In Change problems, the starting amount, the change amount, or the end amount can be the unknown.
- Change problems also may be referred to as Join or Separate problems as they are referred to in the 2016 Virginia Standards of Learning Curriculum Framework.
- A graphic organizer can be used to represent the starting amount, change, and ending amount.
- There are a few unique features in Change problems.
 - First, students must determine if the change amount increases or decreases the end quantity to accurately solve the word problem.

Examples:

- Sarah had \$55. Then, her friend gave her more money to go shopping. Now, Sarah has \$78. How much money did her friend give her? The change amount increases the

overall end quantity and students should use the graphic organizer to show change increase.

- *Sarah had \$55. Then, she gave her friend some money. Now, Sarah has \$32. How much money did Sarah give her friend?* Students should use the graphic organizer to show change decrease because the change amount decreases the overall end quantity.
- Change problems may include several change amounts within the problem that either increase or decrease the end quantity.

Example:

- *Ebony had \$12. Then, her dad gave her \$23. Ebony then spent \$5 on candy. How much money does Ebony have now?* In these cases, the graphic organizer can be altered to show a change increase and then a change decrease.
-
- The figure below shows a worked example of a Change problem.
 - The student used the UPS Check attack strategy to set up and solve the word problem.
 - The student underlined the focus of the problem (i.e., passengers).
 - The student determined that there was no irrelevant information; all of the numbers referenced passengers.
 - The student determined the problem was a Change problem because the problem described a bus that started with some passengers, then more passengers got on the bus.
 - Because the change amount increased the overall end amount (i.e., start amount was 13; end amount was 23), the student used the graphic organizer to organize the numbers from the word problem and show a change increase.
 - The student identified start as 13, change as missing, and end as 28.
 - The student used a question mark to represent the unknown. In this example, the unknown was the change amount.
 - The student subtracted to determine the change amount was 15.
 - The student wrote a label, passengers, for the number answer and checked to make sure the answer made sense (i.e., the sum was greater than both addends).

Sample Change problem

A bus had 13 passengers. At the next stop, more passengers got on the bus. Now, there are 28 passengers. How many passengers got on the bus?

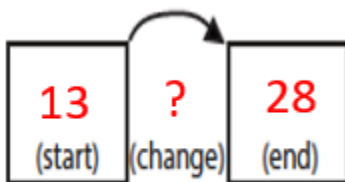

Change = 15 passengers

See [Appendix G](#) which provides a comprehensive overview of the three additive schemas, with definitions, graphic organizers, examples, and variations.

MULTIPLICATIVE SCHEMAS

- The three multiplicative word-problem schemas include Equal Groups, Comparison, and Ratios or Proportions problems.
- The three multiplicative schemas are commonly seen beginning in late elementary and continuing through middle and high school.
- Multiplicative schemas involve word problems in which multiplication or division may be used for solving the problem.
- Just like the additive schemas, the operation (i.e., multiplication or division) does not describe the word problem. Instead, the schema describes the word problem.

1. Equal Groups problems

- In Equal Groups problems, students have groups with an equal number within each group multiplied for a product, or a unit multiplied by a specific rate for a product (Xin & Zhang, 2009).

Example of groups with an equal number within each group:

- *Juan buys 3 boxes of markers with 4 markers in each box. How many markers did he buy?*
- Example with units and rate:
 - *Juan buys 3 jump ropes that cost \$15 each. How much money did Juan spend?*
- These types of problems also are referred to as Equal Groups in the [2016 Virginia Standards of Learning Curriculum Framework \(Grade 4\)](#).
- The schema is considered Equal Groups regardless of whether the problem includes groups or units.
- In Equal Groups problems, the unknown may be the groups or units, the number within each group or rate, or the product.
- After determining that a word problem adheres to the Equal Groups schema, students use the graphic organizer to organize the word-problem information.
- Determining how to apply the numbers from the word problem and use the numbers appropriately often proves difficult for students with learning difficulties; therefore, a graphic organizer makes this task easier.
- The Equal Groups schema typically is introduced as students learn multiplication and division in the elementary grades.
- Similar to the additive problems, students need to use an attack strategy in combination with the word problem's schema. The attack strategy helps students to work through the major steps of the word problem, and the schema assists students in developing a conceptual understanding of the word problem.
- The figure on the next page shows a worked example of an Equal Groups problem.
 - The student used the UPS Check attack strategy to set up and solve the word problem.
 - The student underlined the focus of the problem (i.e., cherries).
 - The student determined that there was no irrelevant information; all of the numbers referenced cherries.
 - The student decided this problem was an Equal Groups problem because the statement asked about the product, or the total number of cherries Ms. Thompson sold from each of the six cartons.
 - The student organized the numbers from the word problem into the equal groups' graphic organizer.
 - The student identified groups as 6 and number as 25. The student used a question mark to represent the unknown. In this example, the unknown was the product.
 - The student multiplied to determine the product was 150.
 - The student wrote a label, cherries, for the number answer and checked to make sure the

answer made sense (i.e., the product was greater than both factors).

Sample Equal Groups problem

Ms. Thompson sold 6 cartons of cherries at the Farmer's Market. Each carton holds 25 cherries. How many cherries did she sell?

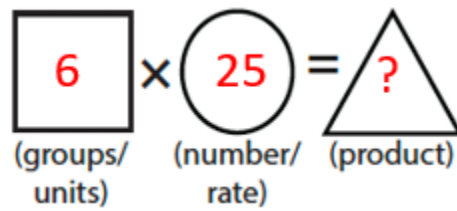

2. Comparison problems

- In Comparison problems, a set is multiplied a number of times for a product.
- The 2016 Virginia Standards of Learning Curriculum Framework also refers to this problem type **Comparison**.
- Most comparison problems require students to determine the product; however, the unknown may be the set, the multiplier, or the product.
- Students can use a graphic organizer or students can visualize the comparison of the original set on a number line.
- Typically, Comparison problems are introduced in the elementary grades after the Equal Groups schema, and students continue to solve Comparison problems throughout late elementary school and into middle school.
- The figure on the following page shows a worked example of a Comparison problem.
 - The student used an open number line and the graphic organizer to focus on the set that was multiplied two times (i.e., twice).
 - The student used the UPS Check attack strategy to set up and solve the word problem.
 - The student underlined the focus of the problem (i.e., flowers).
 - The student also determined that there was no irrelevant information; all of the numbers referenced flowers.
 - The student determined the problem was a Comparison problem because the problem had a set, Emma's flowers, multiplied two times for a product.
 - The student wrote the 6 and 2 in the corresponding spaces for the set and multiplier in the graphic organizer.
 - The student used a question mark in the corresponding area for the product in the graphic organizer to mark the unknown.
 - The student used the number line to count 6 two times and determined the product was 12 (see red arrows in the figure).
 - The student wrote a label, flowers, for the number answer and checked to make sure the answer made sense (i.e., the product was greater than both factors).

Sample Comparison Problem

Isabella has 2 times as many flowers as Emma. Emma has 6 flowers. How many flowers does Isabella have?

U ✓
P ✓
S ✓
✓✓

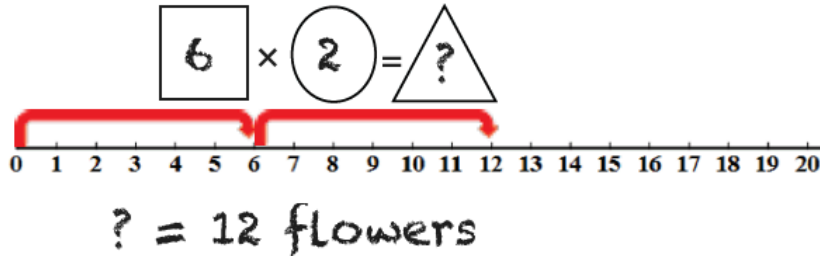

3. Ratios or Proportions problems

- In Ratios or Proportions problems, students identify the relationships among quantities. This schema can be used to solve word problems about ratios, proportions, percentages, or unit rate, and the unknown may be any part of the relationship.
- In middle school, particularly for [Grade 7](#) and [Grade 8](#) in the Virginia Standards of Learning, one of the most widely used schemas that could be used is Ratios or Proportions.
- The figure on the following page presents a worked example of a typical Ratios or Proportions word problem using a graphic organizer from Jitendra and Star (2011).
 - The student used the UPS Check attack strategy to set up and solve the word problem.
 - The student underlined the focus of the problem (i.e., slices of bread).
 - The student determined that there was no irrelevant information; all of the numbers referenced bread.
 - The student determined the problem was a Ratios or Proportions problem because the problem described a relationship among quantities: the number of slices of bread in loaves.
 - The student wrote the 176, 8, and 5 in the corresponding spaces in graphic organizer.
 - The student used a question mark to reference the unknown, or the number of slices in 5 loaves.
 - After the student completed the graphic organizer and filled in the important information, the student could have solved the problem using several methods:
 - The student could have used cross multiplication and division.
 - The student could have identified the relationship between 8 and 176 (i.e., 8 times 22 equals 176) and applied this relationship to the 5 by multiplying 5 by 22.
 - Finally, the student wrote a label, slices, for the number answer of 110 and checked to make sure the answer made sense (i.e., both improper fractions yielded the same number, 22).

Sample Ratios Problem

There are 176 slices of bread in 8 loaves. If there are the same number of slices in each loaf, how many slices of bread are in 5 loaves?

U ✓
P ✓
S ✓
✓✓

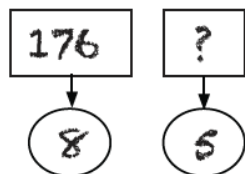

? = 110 slices of bread

- The sample proportions problem below shows how the Ratios or Proportions schema may be presented in another way in middle school.
 - The student was presented with a ratio of 3 to 5.
 - The student learned to interpret this ratio as a fraction (i.e., 3 of every 8 students are boys).
 - By translating the ratio to a fraction, the student was able to use a similar set up to the Proportions problem solved in the sample Ratios problem. In this way, the Ratios or Proportions schema offers flexibility that helps students to solve complex word problems in middle school.

Sample Proportions Problem

Dale Middle School has 440 students. The ratio of boys to girls is 3:5. How many boys are in the school?

$$\frac{3}{8} = \frac{?}{440} \quad ? = 165 \text{ boys}$$

See [Appendix H](#) for a comprehensive overview of the three multiplicative schemas, with definitions, graphic organizers, examples, and variations.

Finally, providing students with verbal and gestural cues to review and recall the six schemas has benefitted students with learning difficulties. As students work to determine the specific schema for a word problem, teachers should include language prompts by asking the following questions:

TOTAL

Are parts put together for a total?

DIFFERENCE

Are two amounts compared for a difference?

CHANGE

Is there a starting amount that increases or decreases to a new amount?

EQUAL GROUPS

Are there groups with an equal number in each group?

COMPARISON

Is there a set compared a number of times?

RATIOS OR PROPORTIONS

Are there relationships among quantities – if this, then this?

As students question, it is recommended that teachers pair the question with an accompanying gesture for each of the six schemas. The [Resource Project STAIR \(Supporting Teaching of Algebra: Individual Readiness\) Youtube channel](#) provides demonstrations of the gestures for Total, Difference, Change, Equal Groups, Comparison, and Ratios or Proportions. Listed below are some of the additional demonstration videos.

RESOURCES

Project STAIR (Supporting Teaching of Algebra: Individual Readiness) Youtube channel

- [Schema Gestures](#) provides a demonstration of the gestures for the three additive schemas (Total, Difference, and Change) and the three multiplicative gestures (Equal Groups, Comparison, Ratios or Proportions).
- [Total Schema](#) provides a demonstration of how to solve Total word problems.
- [Difference Schema](#) provides a demonstration of how to solve Difference word problems.
- [Change Schema](#) provides a demonstration of how to solve Change word problems.
- [Equal Groups Schema](#) provides a demonstration of how to solve Equal Groups word problems.
- [Comparison Schema](#) provides a demonstration of how to solve Comparison word problems.
- [Ratios or Proportions Schema](#) provides a demonstration of how to solve Ratios and Proportions word problems.

SECTION VI: APPENDICIES

APPENDIX A: MODEL FOR EXPLICIT INSTRUCTION: PLANNING GUIDE

MODELING	PRACTICE
Clear Explanation	Guided Practice
Planned Examples	Independent Practice
SUPPORTS DURING MODELING AND PRACTICE	
<p>Ask high and low level questions.</p> <p>Elicit frequent responses.</p> <p>Provide immediate affirmative and corrective feedback.</p> <p>Maintain a brisk pace.</p>	

National Center for Intensive Intervention

APPENDIX B: FORMAL MATHEMATICS LANGUAGE GRAPHIC ORGANIZERS

INSTEAD OF THAT.....	SAY THIS.....
<p>Numbers in the Fraction <u>Problem:</u> Language suggests that each part of a fraction (i.e., numerator, denominator) is a separate and independent number instead of a digit (or series of digits) that comprise a fraction.</p>	<p>This fraction is a number <u>Solution:</u> A fraction is a number in itself and has a magnitude on a number line. A fraction is not two separate numbers.</p>
<p>Top number and bottom number <u>Problem:</u> This suggests that the numerator and denominator are separate and independent numbers.</p>	<p>Numerator and Denominator <u>Solution:</u> A fraction is a number with a specific magnitude that can be represented on a number line. While a fraction may have different parts, these parts do not work in isolation but rather contribute to one number – the fraction.</p>
<p>Two over three <u>Problem:</u> This communicates the location of the digits but not the actual number and magnitude.</p>	<p>e.g., Two-Thirds <u>Solution:</u> This is accurate and communicates the magnitude of the number.</p>
<p>Line <u>Problem:</u> Calling the fraction bar a line is inexact vocabulary.</p>	<p>Fraction bar or slash <u>Solution:</u> The fraction bar or slash plays an important role in communicating the divisional relationship between the numerator and denominator.</p>
<p>Reduce <u>Problem:</u> This term (as in “reduce to the lowest term”) suggests the result is less in quantity.</p>	<p>Rename or find an equivalent fraction <u>Solution:</u> The quantity represented by the magnitude of the fraction does not change. The only change is with the digits used to communicate that magnitude.</p>
<p>Point <u>Problem:</u> Reading a decimal as “three point four” does not support the conceptual understanding of place value of the magnitude of the decimal.</p>	<p>Three and four tenths <u>Solution:</u> This reinforces place value and supports understanding of magnitudes, values, and when to use each symbol.</p>
<p>Move the decimal point over <u>Problem:</u> This language “just” communicates what is superficially occurring- that action. This language does not promote conceptual understanding when multiplying or dividing by powers of ten.</p>	<p>Demonstrate the process in base ten <u>Solution:</u> Helps with understanding the process of multiplying or dividing by a power of ten.</p>
<p>Out of <u>Problem:</u> When talking about ratios, this language is incorrect because it does not communicate the ratio of one number to another number but one number to the whole.</p>	<p>E.g., three to four <u>Solution:</u> Although a minor change in language, the meaning is very different.</p>



Informal and formal mathematical language related to numbers and operations with rational numbers (Hughes et al., 2016)

INSTEAD OF THAT.....	SAY THIS.....
<p>Box or ball <u>Problem:</u> With early descriptions of shapes, children use terms that relate to real-life objects. This is permissible but formal language should also be reinforced.</p>	<p>Square, rectangle, or circle <u>Solution:</u> Use formal language of shapes to confirm informal language.</p>
<p>Square for any rectangular shape <u>Problem:</u> A square has 4 congruent sides and 4 right angles. A square is a rectangle, but a rectangle is not necessarily a square.</p>	<p>Rectangle <u>Solution:</u> Use the formal language of shapes to confirm informal language.</p>
<p>Corner <u>Problem:</u> This general vocabulary term is not mathematically accurate</p>	<p>Angle <u>Solution:</u> Reinforce that an angle is the space between two intersecting lines</p>
<p>Point for 3-dimensional figures <u>Problem:</u> This general vocabulary term is not mathematically accurate.</p>	<p>Vertex <u>Solution:</u> This is the endpoint where two or more line segments or rays meet.</p>
<p>Same (e.g. "these halves are the same") <u>Problem:</u> This term does not convey conceptual meaning.</p>	<p>Symmetrical <u>Solution:</u> This term should be used to describe a reflection of a shape.</p>
<p>Flips, slides, and turns <u>Problem:</u> These terms help children remember the action of the transformation.</p>	<p>Reflections, translations, and rotations <u>Solution:</u> These are the correct mathematical terms.</p>
<p>Stretch or Shrink <u>Problem:</u> These terms help children remember the action of the transformation.</p>	<p>Dilation <u>Solution:</u> This is the proper mathematical term.</p>

Informal and formal mathematical language related to geometry and measurement (Hughes et al., 2016)

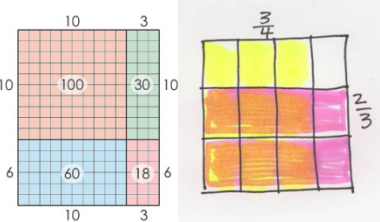
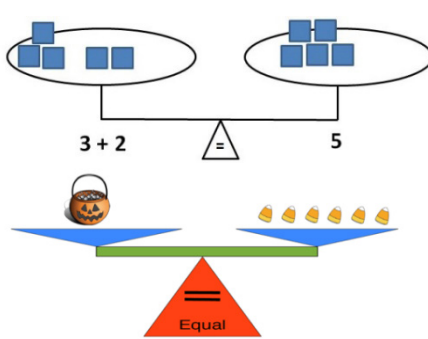
APPENDIX C: MATHEMATICS INSTRUCTIONAL CONNECTIONS FOR PHYSICAL AND VISUAL REPRESENTATIONS

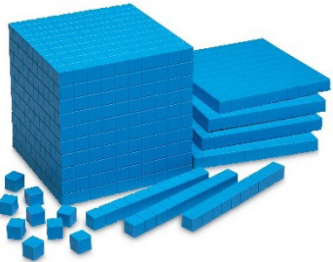
REPRESENTATION	CONTENT CONNECTIONS
<p>Algebra Tiles</p> 	<ul style="list-style-type: none"> • Operations with integers and polynomial expressions • Model and factor linear and quadratic expressions <p>Challenges or limitations could include:</p> <ul style="list-style-type: none"> • Modeling expressions other than linear and quadratic • Factoring non-factorable quadratic expressions
 <p>Arrays</p> <p>X X X X X X X X X X X X</p> <p>4 rows of 3</p>	<ul style="list-style-type: none"> • Multiplication and division of whole numbers • Operations with fractions • Area and perimeter • Distributive Property • Commutative Property
<p>Balance Scale</p> 	<ul style="list-style-type: none"> • Properties of equality • Equality • Model one-variable equations • Solve one-variable equations

REPRESENTATION	CONTENT CONNECTIONS
<p>Base Ten Blocks</p> 	<ul style="list-style-type: none"> • One-to-one correspondence • Count and skip count • Place value • Represent whole numbers and decimals • Compare and order compare whole numbers and decimals • Operations with whole numbers and decimals • Powers of 10 <p><i>Challenges or limitations could include:</i></p> <ul style="list-style-type: none"> • Modeling large numbers • Interlocking cubes most appropriate for PreK-Grade 1
<p>Counters</p> 	<ul style="list-style-type: none"> • One-to-one correspondence • Count and skip count • Odd and even numbers • Compose and decompose numbers • Operations with whole numbers • Ratios and fractions (set model) • Probability • Measurement
<p>Cubes</p> 	<ul style="list-style-type: none"> • One-to-one correspondence • Count and skip count • Ratios and fractions (set model) • Probability • Construct two- and three-dimensional figures, perspective drawings • Measurement

REPRESENTATION

CONTENT CONNECTIONS

Equation Mats

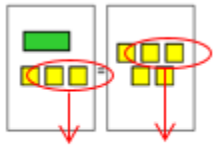

$$x + 3 = 5$$

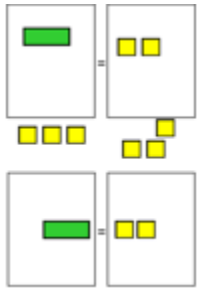

$$\begin{aligned} x + 3 &= 5 \\ -3 \quad -3 & \\ \hline x &= 2 \end{aligned}$$

Integer Mats

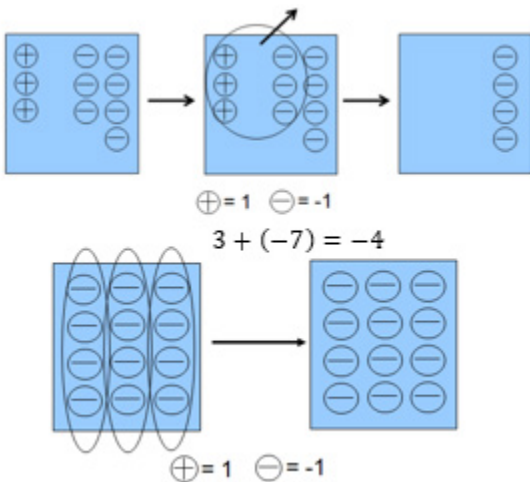

three groups of -4

Five and Ten Frames, Rekenreks, Dot Cards

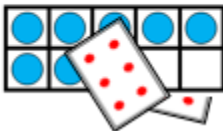
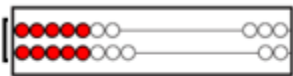





- Model equations
- Solve equations
- Model operations with integers

Challenges or limitations could include:

- Modeling multiplication versus division (motion may be required to build understanding of division)
- Modeling division by negative integers

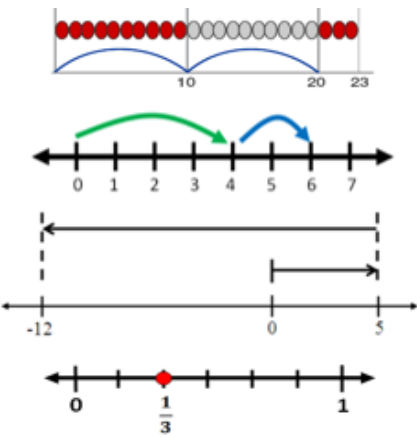
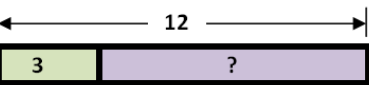
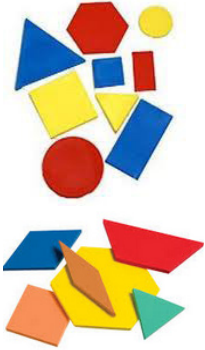

- One-to-one correspondence
- Count and skip count
- Place value
- Subitize
- Compose and decompose numbers
- Related facts (addition and subtraction)

REPRESENTATION	CONTENT CONNECTIONS																																																																																																				
<p>Fraction Models</p> <p>Bars Circles Rods</p> 	<ul style="list-style-type: none"> • Represent fractions (area or length model) • Equivalent fractions • Compare and order fractions • Operations with fractions <p><i>Challenges or limitations could include:</i></p> <ul style="list-style-type: none"> • Modeling certain fractions 																																																																																																				
<p>Hundreds Chart</p> <table border="1" data-bbox="110 598 349 850"> <tr><td>1</td><td>2</td><td>3</td><td>4</td><td>5</td><td>6</td><td>7</td><td>8</td><td>9</td><td>10</td></tr> <tr><td>11</td><td>12</td><td>13</td><td>14</td><td>15</td><td>16</td><td>17</td><td>18</td><td>19</td><td>20</td></tr> <tr><td>21</td><td>22</td><td>23</td><td>24</td><td>25</td><td>26</td><td>27</td><td>28</td><td>29</td><td>30</td></tr> <tr><td>31</td><td>32</td><td>33</td><td>34</td><td>35</td><td>36</td><td>37</td><td>38</td><td>39</td><td>40</td></tr> <tr><td>41</td><td>42</td><td>43</td><td>44</td><td>45</td><td>46</td><td>47</td><td>48</td><td>49</td><td>50</td></tr> <tr><td>51</td><td>52</td><td>53</td><td>54</td><td>55</td><td>56</td><td>57</td><td>58</td><td>59</td><td>60</td></tr> <tr><td>61</td><td>62</td><td>63</td><td>64</td><td>65</td><td>66</td><td>67</td><td>68</td><td>69</td><td>70</td></tr> <tr><td>71</td><td>72</td><td>73</td><td>74</td><td>75</td><td>76</td><td>77</td><td>78</td><td>79</td><td>80</td></tr> <tr><td>81</td><td>82</td><td>83</td><td>84</td><td>85</td><td>86</td><td>87</td><td>88</td><td>89</td><td>90</td></tr> <tr><td>91</td><td>92</td><td>93</td><td>94</td><td>95</td><td>96</td><td>97</td><td>98</td><td>99</td><td>100</td></tr> </table>	1	2	3	4	5	6	7	8	9	10	11	12	13	14	15	16	17	18	19	20	21	22	23	24	25	26	27	28	29	30	31	32	33	34	35	36	37	38	39	40	41	42	43	44	45	46	47	48	49	50	51	52	53	54	55	56	57	58	59	60	61	62	63	64	65	66	67	68	69	70	71	72	73	74	75	76	77	78	79	80	81	82	83	84	85	86	87	88	89	90	91	92	93	94	95	96	97	98	99	100	<ul style="list-style-type: none"> • One-to-one correspondence • Count and skip count • Multiples • Odd and even numbers • Prime and composite numbers • Operations with whole numbers
1	2	3	4	5	6	7	8	9	10																																																																																												
11	12	13	14	15	16	17	18	19	20																																																																																												
21	22	23	24	25	26	27	28	29	30																																																																																												
31	32	33	34	35	36	37	38	39	40																																																																																												
41	42	43	44	45	46	47	48	49	50																																																																																												
51	52	53	54	55	56	57	58	59	60																																																																																												
61	62	63	64	65	66	67	68	69	70																																																																																												
71	72	73	74	75	76	77	78	79	80																																																																																												
81	82	83	84	85	86	87	88	89	90																																																																																												
91	92	93	94	95	96	97	98	99	100																																																																																												
<p>Linking Cubes</p> 	<ul style="list-style-type: none"> • One-to-one correspondence • Count and skip count • Odd and even numbers • Compose and decompose numbers • Place value • Ratios, fractions (set, area, or length model), and decimals • Operations with whole numbers • Operations with fractions (like denominators only) • Probability and data collection • Construct two- and three-dimensional figures • Measurement 																																																																																																				

REPRESENTATION	CONTENT CONNECTIONS
<p>Number Lines</p>  <p>Bar Model</p> 	<ul style="list-style-type: none"> Count and skip count Place value Represent fractions (length model), decimals, and integers Compare, order, and operate with whole numbers, fractions, decimals, and integers Measurement Represent data (line plots, balance point/mean) Probability Represent absolute value <p><i>Challenges or limitations could include:</i></p> <ul style="list-style-type: none"> Modeling multiplication versus division (motion required to build understanding) Modeling division by negative integers Modeling with number 'paths' most appropriate for PreK-Grade 1
<p>Pattern Blocks</p> 	<ul style="list-style-type: none"> Sort and classify geometric figures (attributes) Compose and decompose geometric figures Patterns Represent fractions (area model) Equivalent fractions/Compare fractions Operations with fractions Ratios <p><i>Challenges or limitations could include:</i></p> <ul style="list-style-type: none"> Modeling certain fractions
<p>Two-color Counters</p> 	<ul style="list-style-type: none"> One-to-one correspondence Compose and decompose numbers Represent Integers Properties of integers Operations with whole numbers and integers Probability Ratios Challenges or limitations could include: Modeling multiplication and division by negative integers

Virginia Department of Education, 2014
 (note this is not an exhaustive list)

APPENDIX D: FLUENCY GAMES AND ACTIVITIES

ACTIVITY	INSTRUCTIONS	PICTURE
<p>Playing Cards <i>Group Activity</i></p>	<p>BEFORE</p> <ol style="list-style-type: none"> 1. Select numbered playing cards from a deck of cards <p>DURING</p> <ol style="list-style-type: none"> 1. Divide deck in half 2. Students place set of cards face down 3. Players each draw two cards and the player with the higher product, sum etc. keeps the cards. 4. Students continue until one student has all the cards <p>This game is similar to War.</p>	
<p>Dice Roll <i>Individual Activity</i></p>	<p>DURING</p> <ol style="list-style-type: none"> 1. Student rolls two die 2. Student adds, subtracts, or multiplies 3. Student writes facts 	<p>Roll the Dice </p> <p> $_ + _ = _$ $_ + _ = _$ $_ + _ = _$ $_ + _ = _$ $_ - _ = _$ $_ - _ = _$ $_ - _ = _$ $_ - _ = _$ </p>
<p>Dominos <i>Individual Activity</i></p>	<p>DURING</p> <ol style="list-style-type: none"> 1. Student select domino 2. Student adds, subtracts, or multiplies 3. Student writes fact 	<p>Dominos </p> <p> $_ + _ = _$ $_ + _ = _$ $_ + _ = _$ $_ + _ = _$ $_ - _ = _$ $_ - _ = _$ $_ - _ = _$ $_ - _ = _$ </p>

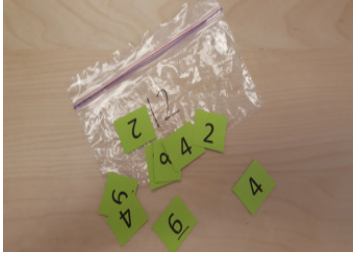
ACTIVITY	INSTRUCTIONS	PICTURE																	
<p>Magic Squares <i>Individual Activity</i></p>	<p>BEFORE</p> <ol style="list-style-type: none"> 1. Create sets of magic squares <p>DURING</p> <ol style="list-style-type: none"> 1. Place sum or product in bottom right corner 2. In bottom row, create a fact with a sum or product of bottom right corner 3. In right column, create a fact with a sum or product of bottom right corner 4. Create two columns with a sum or product of bottom number 5. Create two rows with a sum or product of right column number 6. Write created facts <p>Magic Squares Template Adding Magic Squares Multiplication Magic Squares</p>	<p>Magic Squares</p> <table border="1" data-bbox="1068 184 1422 420"> <tr> <td></td> <td></td> <td></td> </tr> <tr> <td></td> <td></td> <td></td> </tr> <tr> <td></td> <td></td> <td>(Place sum or product from baggie here)</td> </tr> </table> <p>Write the facts:</p> <table data-bbox="1068 457 1373 592"> <tr> <td>_____</td> <td>_____</td> </tr> <tr> <td>_____</td> <td>_____</td> </tr> <tr> <td>_____</td> <td>_____</td> </tr> <tr> <td>_____</td> <td>_____</td> </tr> </table> 									(Place sum or product from baggie here)	_____	_____	_____	_____	_____	_____	_____	_____
		(Place sum or product from baggie here)																	
_____	_____																		
_____	_____																		
_____	_____																		
_____	_____																		
<p>Cover, Copy, Compare <i>Individual Activity</i></p>	<p>BEFORE</p> <ol style="list-style-type: none"> 1. Create an activity with 10-12 answered problems and space to copy facts <p>DURING</p> <ol style="list-style-type: none"> 1. Student reads entire fact 2. Student covers fact 3. Student rewrites entire fact 4. Student compares 	<p>Cover, Copy, Compare</p> <table border="1" data-bbox="1062 1020 1432 1491"> <tr> <td>$\begin{array}{r} 9 \\ \times 6 \\ \hline 54 \end{array}$</td> <td>$\begin{array}{r} 8 \\ \times 6 \\ \hline 48 \end{array}$</td> </tr> <tr> <td>$\begin{array}{r} 7 \\ \times 8 \\ \hline 56 \end{array}$</td> <td>$\begin{array}{r} 6 \\ \times 5 \\ \hline 30 \end{array}$</td> </tr> <tr> <td>$\begin{array}{r} 9 \\ \times 9 \\ \hline 81 \end{array}$</td> <td>$\begin{array}{r} 7 \\ \times 9 \\ \hline 63 \end{array}$</td> </tr> <tr> <td>$\begin{array}{r} 6 \\ \times 7 \\ \hline 42 \end{array}$</td> <td>$\begin{array}{r} 8 \\ \times 5 \\ \hline 40 \end{array}$</td> </tr> <tr> <td>$\begin{array}{r} 8 \\ \times 8 \\ \hline 64 \end{array}$</td> <td>$\begin{array}{r} 7 \\ \times 7 \\ \hline 49 \end{array}$</td> </tr> </table>	$\begin{array}{r} 9 \\ \times 6 \\ \hline 54 \end{array}$	$\begin{array}{r} 8 \\ \times 6 \\ \hline 48 \end{array}$	$\begin{array}{r} 7 \\ \times 8 \\ \hline 56 \end{array}$	$\begin{array}{r} 6 \\ \times 5 \\ \hline 30 \end{array}$	$\begin{array}{r} 9 \\ \times 9 \\ \hline 81 \end{array}$	$\begin{array}{r} 7 \\ \times 9 \\ \hline 63 \end{array}$	$\begin{array}{r} 6 \\ \times 7 \\ \hline 42 \end{array}$	$\begin{array}{r} 8 \\ \times 5 \\ \hline 40 \end{array}$	$\begin{array}{r} 8 \\ \times 8 \\ \hline 64 \end{array}$	$\begin{array}{r} 7 \\ \times 7 \\ \hline 49 \end{array}$							
$\begin{array}{r} 9 \\ \times 6 \\ \hline 54 \end{array}$	$\begin{array}{r} 8 \\ \times 6 \\ \hline 48 \end{array}$																		
$\begin{array}{r} 7 \\ \times 8 \\ \hline 56 \end{array}$	$\begin{array}{r} 6 \\ \times 5 \\ \hline 30 \end{array}$																		
$\begin{array}{r} 9 \\ \times 9 \\ \hline 81 \end{array}$	$\begin{array}{r} 7 \\ \times 9 \\ \hline 63 \end{array}$																		
$\begin{array}{r} 6 \\ \times 7 \\ \hline 42 \end{array}$	$\begin{array}{r} 8 \\ \times 5 \\ \hline 40 \end{array}$																		
$\begin{array}{r} 8 \\ \times 8 \\ \hline 64 \end{array}$	$\begin{array}{r} 7 \\ \times 7 \\ \hline 49 \end{array}$																		

File Folder
Individual Activity

- BEFORE**
1. Create an activity with 15-25 answered facts
- DURING**
1. Student folds answers over
 2. Student writes answers to all facts
 3. Student unfolds answers and compares

File Folder

6 + 3 =	9
1 + 7 =	8
6 + 4 =	10
7 + 3 =	10
2 + 7 =	9
5 + 6 =	11
4 + 7 =	11
7 + 8 =	15
6 + 7 =	13
7 + 9 =	16
7 + 6 =	13
8 + 7 =	15
7 + 0 =	7
9 + 6 =	15
6 + 0 =	6
6 + 8 =	14

Worksheets with Graphing
Individual Activity

- DURING**
1. Students answer facts for a few minutes
 2. Students graph highest score of day or week

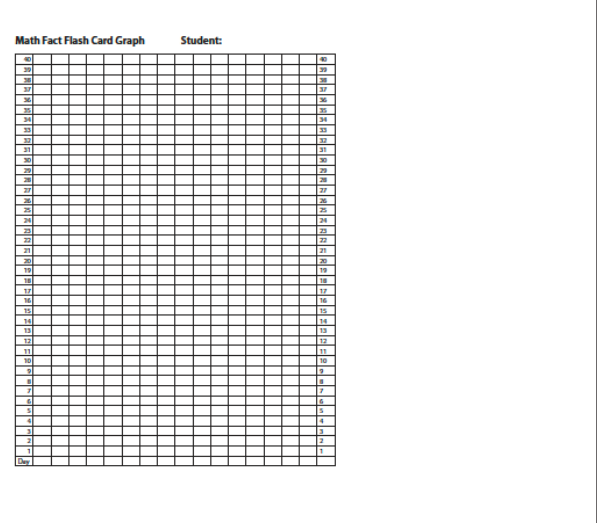

Taped Problems
Individual or Group Activity

- BEFORE**
1. Create activity with 15-25 facts
 2. Make a recording:
-Say fact (e.g., "1 times 3 equals...")
-Pause for 1-5 seconds
-Say fact answer (e.g., "3")
-Continue with all facts on page
- DURING**
1. Student listens to recording
 2. Student writes fact answer before the answer is stated on the recording

Taped Problems

6 × 5	8 × 6	7 × 9	6 × 8
9 × 8	8 × 5	7 × 8	6 × 6
7 × 7	6 × 9	5 × 9	8 × 4
9 × 4	6 × 9	9 × 5	8 × 7
6 × 7	8 × 8	4 × 8	5 × 7

APPENDIX E: ALGORITHMS FOR ADDITION, SUBTRACTION, MULTIPLICATION, AND DIVISION

ADDITION

Traditional:

$$\begin{array}{r} 1 \\ 74 \\ + 18 \\ \hline 92 \end{array}$$

$$\begin{array}{r} 1 1 \\ 725 \\ + 365 \\ \hline 1,090 \end{array}$$

Visual Model:

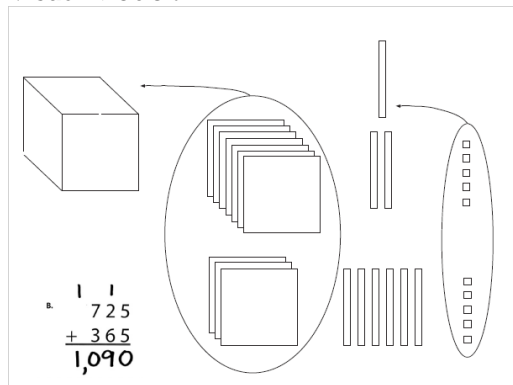

Partial Sums:

$$\begin{array}{r} 74 \\ + 18 \\ \hline 80 \\ + 12 \\ \hline 92 \end{array}$$

$$\begin{array}{r} 725 \\ + 365 \\ \hline 1,000 \\ 80 \\ + 10 \\ \hline 1,090 \end{array}$$

Opposite Change: Round one number to nearest ten; amount added is subtracted from the other number

$$\begin{array}{r} 74 \xrightarrow{-4} 70 \\ + 18 \xrightarrow{+4} +22 \\ \hline 92 \end{array}$$

$$\begin{array}{r} 725 \xrightarrow{+5} 730 \\ + 365 \xrightarrow{-5} +360 \\ \hline 1,090 \end{array}$$

SUBTRACTION

Traditional:

A.

$$\begin{array}{r} 5 \\ \cancel{1}2 \\ - 17 \\ \hline 45 \end{array}$$

B.

$$\begin{array}{r} 29 \\ \cancel{1}0\cancel{1}5 \\ - 96 \\ \hline 209 \end{array}$$

Visual Model:

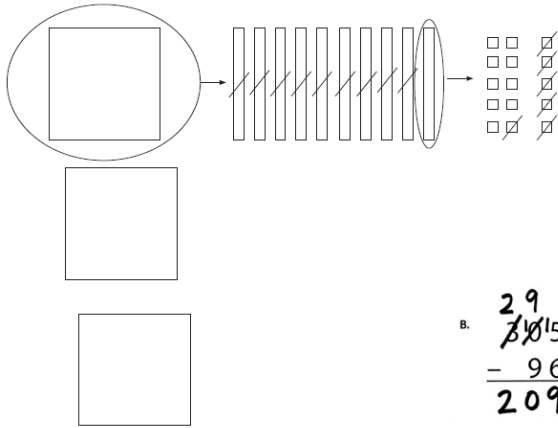

Partial Differences:

A.

$$\begin{array}{r} 62 \\ - 17 \\ \hline +50 \\ - 5 \\ \hline 45 \end{array}$$

B.

$$\begin{array}{r} 305 \\ - 96 \\ \hline +300 \\ -90 \\ -1 \\ \hline 209 \end{array}$$

Same Change: Change subtrahend to end in 0

A.

$$\begin{array}{r} 62 \xrightarrow{+3} 65 \\ - 17 \xrightarrow{+3} -20 \\ \hline 45 \end{array}$$

B.

$$\begin{array}{r} 305 \xrightarrow{+4} 309 \\ - 96 \xrightarrow{+4} -100 \\ \hline 209 \end{array}$$

SUBTRACTION

Add Up:

Start with the subtrahend and use addends to add up to benchmarks and record the add-up amount. Continue adding up until you reach the minuend. Then, to find the difference between the subtrahend and minuend, find the total of all the addends.

A.

$$\begin{array}{r} 62 \\ - 17 \\ \hline \end{array}$$
$$\begin{array}{r} 17 \\ 20 \\ 60 \\ \hline 62 \end{array}$$
$$\begin{array}{r} 3 \\ 40 \\ + 2 \\ \hline 45 \end{array}$$

B.

$$\begin{array}{r} 305 \\ - 96 \\ \hline \end{array}$$
$$\begin{array}{r} 96 \\ 100 \\ 300 \\ \hline 305 \end{array}$$
$$\begin{array}{r} 4 \\ 200 \\ + 5 \\ \hline 209 \end{array}$$

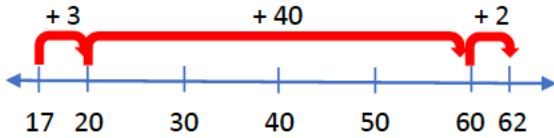

MULTIPLICATION

Traditional:

A.
$$\begin{array}{r}
 24 \\
 \times 43 \\
 \hline
 72 \\
 960 \\
 \hline
 1,032
 \end{array}$$

B.
$$\begin{array}{r}
 132 \\
 \times 53 \\
 \hline
 396 \\
 6600 \\
 \hline
 6,996
 \end{array}$$

Visual Model:

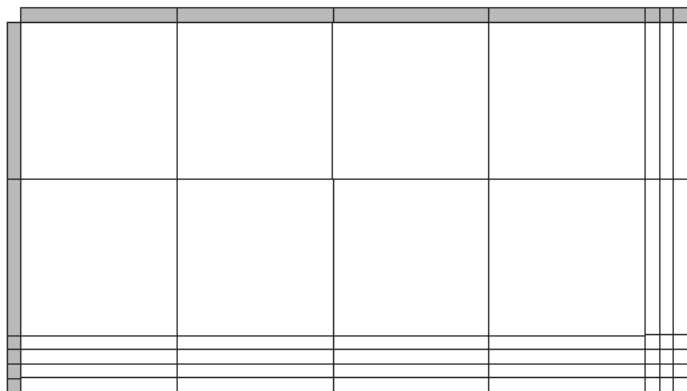

A.
$$\begin{array}{r}
 24 \\
 \times 43 \\
 \hline
 72 \\
 960 \\
 \hline
 1,032
 \end{array}$$

Partial Products:

A.
$$\begin{array}{r}
 24 \\
 \times 43 \\
 \hline
 800 \\
 160 \\
 60 \\
 + 12 \\
 \hline
 1,032
 \end{array}$$

B.
$$\begin{array}{r}
 132 \\
 \times 53 \\
 \hline
 5000 \\
 15000 \\
 1000 \\
 300 \\
 90 \\
 6 \\
 + \\
 \hline
 6996
 \end{array}$$

Area:

A.
$$\begin{array}{r}
 24 \\
 \times 43 \\
 \hline
 800 \\
 160 \\
 60 \\
 + 12 \\
 \hline
 1,032
 \end{array}$$

B.
$$\begin{array}{r}
 132 \\
 \times 53 \\
 \hline
 5000 \\
 15000 \\
 1000 \\
 300 \\
 90 \\
 6 \\
 + \\
 \hline
 6996
 \end{array}$$

DIVISION

Traditional:

$$\begin{array}{r} 13 \text{ R}2 \\ 12 \overline{)158} \\ \underline{-12} \\ 38 \\ \underline{-36} \\ 2 \end{array}$$

$$\begin{array}{r} 28 \text{ R}18 \\ 34 \overline{)870} \\ \underline{-68} \\ 290 \\ \underline{-272} \\ 18 \end{array}$$

Visual Model:

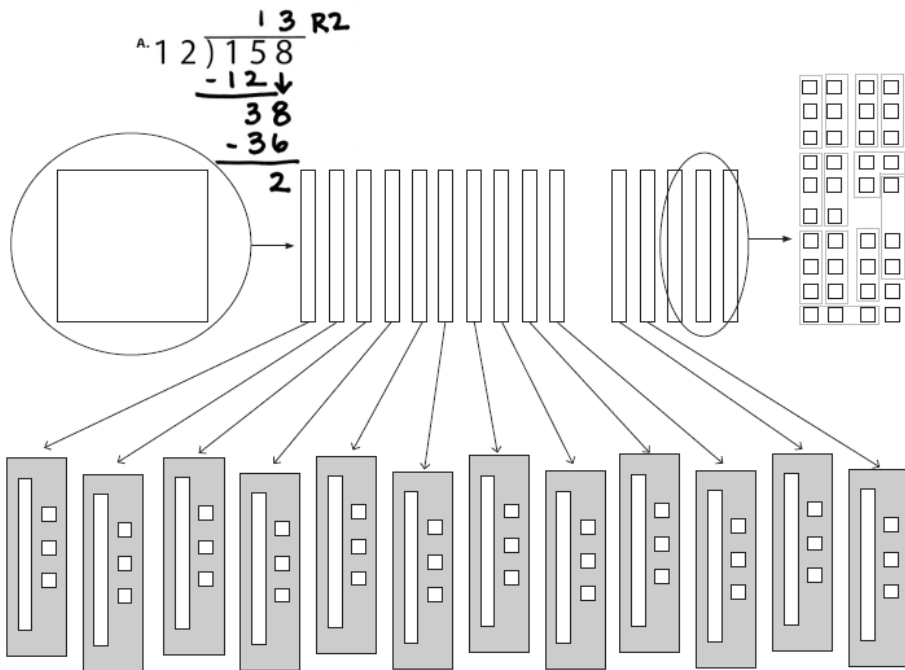

Partial Quotients:

$$\begin{array}{r} 12 \overline{)158} \\ \underline{-120} \quad 10 \\ 38 \\ \underline{-36} \quad +3 \\ 2 \quad 13 \text{ R}2 \end{array}$$

$$\begin{array}{r} 34 \overline{)870} \\ \underline{-680} \quad 20 \\ 290 \\ \underline{-170} \quad 5 \\ 120 \\ \underline{102} \quad +3 \\ 18 \quad 28 \text{ R}18 \end{array}$$

DIVISION

Bar Diagram Partial Quotients Model

$$1506 \div 3$$

$$200 + 200 + 100 + 2 = 502$$

3	$\begin{array}{r} 1506 \\ -600 \\ \hline 906 \end{array}$	$\begin{array}{r} 906 \\ -600 \\ \hline 306 \end{array}$	$\begin{array}{r} 306 \\ -300 \\ \hline 6 \end{array}$	$\begin{array}{r} 6 \\ -6 \\ \hline 0 \end{array}$

APPENDIX F: PROBLEM SOLVING ATTACK STRATEGIES

<p><u>U</u>nderstand <u>P</u>lan <u>S</u>olve <u>C</u>heck <i>(adapted from Pólya, 2009)</i></p>	<p><u>F</u>ind the problem <u>O</u>rganize information using a diagram <u>P</u>lan to solve the problem <u>S</u>olve the Problem <i>(Jitendra and Star, 2012)</i></p>
<p><u>S</u>earch the word problem <u>T</u>ranslate the words into an equation or picture <u>A</u>nsWER the Problem <u>R</u>eview the solution <i>(Gagnon and Maccini, 2001)</i></p>	<p>Read (for understanding) Paraphrase (your own words) Visualize (a picture or a diagram) Hypothesize (a plan to solve the problem) Estimate (predict the answer) Compute (do the arithmetic) <i>(Montague, 2008)</i></p>

APPENDIX G: COMPREHENSIVE OVERVIEW OF ADDITIVE SCHEMAS

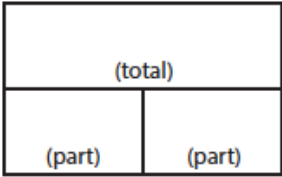
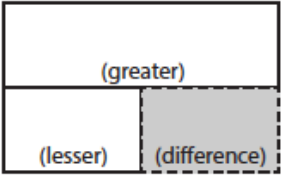
SCHEMA AND DEFINITION	GRAPHIC ORGANIZERS	EXAMPLES	VARIATIONS
<p>Total (Combine; Part-part-whole) Parts combined for a sum</p>		<p><i>Sum unknown:</i> Sally has 12 red markers and 13 purple markers. How many markers does Sally have altogether?</p> <p><i>Part unknown:</i> Sally has 25 red and purple markers. If 12 of the markers are red, how many markers are purple?</p>	<p><i>More than two parts:</i> Sally has 34 markers. Of the markers, 12 are red, 13 are purple, and the rest are green. How many green markers does Sally have?</p>
<p>Difference (Compare) An amount that is greater and an amount that is less compared for a difference; sets compared for a difference</p>		<p><i>Difference unknown:</i> Sebastian scored 12 goals. James scored 19 goals. How many fewer goals did Sebastian score?</p> <p><i>Greater unknown:</i> James scored 7 more goals than Sebastian. If Sebastian scored 12 goals, how many goals did James score?</p> <p><i>Less unknown:</i> James scored 19 goals. Sebastian scored 7 fewer goals than James. How many goals did Sebastian score?</p>	<p>(None)</p>

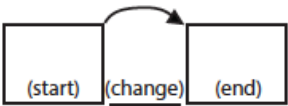
SCHEMA AND DEFINITION	GRAPHIC ORGANIZERS	EXAMPLES	VARIATIONS
<p>Change (Join; Separate) <i>An amount that increases or decreases to a new amount</i></p>		<p>Change Increase: <i>End (increase) unknown:</i> Anabel had \$32. Then, she earned \$15 for cleaning her room. How much money does Anabel have now?</p> <p><i>Change (increase) unknown:</i> Anabel had \$32. Then, she earned some money for cleaning her room. Now, Anabel has \$47. How much money did Anabel earn for cleaning her room?</p> <p><i>Start (increase) unknown:</i> Anabel had some money. Then, she earned \$12 for cleaning her room. Now, Anabel has \$47. How much money did Anabel have to start with?</p> <p>Change Decrease: <i>End (decrease) unknown:</i> Anabel had \$32. Then, she spent \$12 at the arcade. How much money does Anabel have now?</p> <p><i>Change (decrease) unknown:</i> Anabel had \$32. Then, she spent some money at the arcade. Now, Anabel has \$20. How much money did Anabel spend at the arcade?</p> <p><i>Start (decrease) unknown:</i> Anabel had some money. Then, she spent \$12 at the arcade. Now, Anabel has \$20. How much money did Anabel have to start with?</p>	<p><i>Multiple changes:</i> Anabel had \$32. She earned \$15 for cleaning her room and then she spent \$12 at the arcade. How much money does Anabel have now?</p>

Comprehensive overview of additive schemas.

APPENDIX H: COMPREHENSIVE OVERVIEW OF MULTIPLICATIVE SCHEMAS

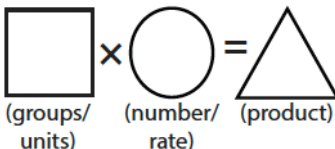
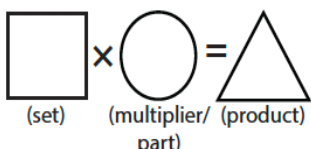
SCHEMA AND DEFINITION	GRAPHIC ORGANIZERS	EXAMPLES	VARIATIONS
<p>Equal Groups; Vary <i>A group with an equal number within each group multiplied for a product; a unit multiplied by a specific rate for a product</i></p>		<p><i>Product unknown:</i> A classroom has 6 rows of chairs with 5 chairs per row. How many chairs are in the classroom?</p> <p><i>Groups unknown:</i> A classroom has rows of chairs with 5 chairs per row. If there are 30 chairs, how many rows are there?</p> <p><i>Number within groups unknown:</i> A classroom has 6 rows of chairs with an equal number of chairs in each row. If there are 30 chairs in the classroom, how many chairs are in each row?</p>	<p><i>With rate:</i> A teacher bought 30 new chairs for her classroom. Each chair cost \$12.50. How much money did the teacher spend on chairs?</p>
<p>Comparison <i>A set multiplied a number of times for a product</i></p>		<p><i>Product unknown:</i> Kyara has 8 stickers. Charlotte has 3 times as many stickers. How many stickers does Charlotte have?</p> <p><i>Set unknown:</i> Charlotte has 3 times as many stickers as Kyara. If Charlotte has 24 stickers, how many stickers does Kyara have?</p> <p><i>Times unknown:</i> Kyara has 8 stickers. Charlotte has 24 stickers. How many times more stickers does Charlotte have?</p>	<p><i>With fraction:</i> Kyara has 25 blue and green stickers. If 1/5 of the stickers are green, how many are blue?</p>

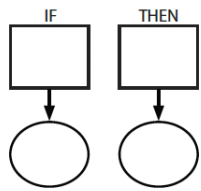
SCHEMA AND DEFINITION	GRAPHIC ORGANIZERS	EXAMPLES	VARIATIONS
<p>Ratios or Proportions <i>Relationships among quantities</i></p>		<p><i>Subject unknown:</i> Marianne ran 12 laps in 3 minutes. How many laps could Marianne run in 15 minutes?</p> <p><i>Object unknown:</i> Marianne ran 12 laps in 3 minutes. How many minutes would it take Marianne to run 60 laps?</p>	<p><i>With percentage:</i> Marianne received a 90% on her spelling test. If the test had 40 questions, how many questions did Marianne answer correctly?</p>

Comprehensive overview of multiplicative schemas.

SECTION VIII: REFERENCES

- Archer, A. L., Hughes, C. A. (2011). *Explicit Instruction: Effective and Efficient Teaching*. United States: Guilford Publications.
- Flores, M. M., Hinton, V., & Strozier, S. D. (2014). [Teaching subtraction and multiplication with regrouping using the concrete-representational-abstract sequence and strategic instruction model](#). *Learning Disabilities Research and Practice*, 29, 75–88.
- Freeman, B., & Crawford, L. (2008). [Creating a middle school mathematics curriculum for English-Language Learners](#). *Remedial and Special Education*, 29, 9–19.
- Fuchs, L. S., Fuchs, D. & Prentice, K. (2004). [Responsiveness to mathematical problem-solving instruction: Comparing students at risk of mathematics disability with and without risk of reading disability](#). *Journal of Learning Disabilities*, 37, 293–306.
- Fuchs, L. S., Powell, S. R., Cirino, P. T., Schumacher, R. F., Marrin, S., Hamlett, C. L., Fuchs, D., Compton, D. L., & Changas, P. C. (2014). [Does calculation or word-problem instruction provide a stronger route to pre-algebraic knowledge?](#) *Journal of Educational Psychology*, 106(4), 990–1006.
- Fuchs, L. S., Seethaler, P. M., Powell, S. R., Fuchs, D., Hamlett, C. L., & Fletcher, J. M. (2008). [Effects of preventative tutoring on the mathematical problem solving of third-grade students with math and reading difficulties](#). *Exceptional Children*, 74, 155–173.
- Gagnon, J. C., & Maccini, P. (2001). [Preparing students with disabilities for algebra](#). *TEACHING Exceptional Children*, 34, 8–15.
- Griffin, C. & Jitendra, A. (2009). [Word problem-solving instruction in inclusive third-grade mathematics classrooms](#). *Educational Psychology*, 102, 187–201.
- Hudson, P., Miller, S. P., & Butler, F. (2006). Adapting and merging explicit instruction with reform based mathematics classrooms. *American Secondary Education*, 35, 19–32.
- Hughes, E. M., Powell, S. R., & Stevens, E. A. (2016). [Supporting clear and concise mathematics language](#). *TEACHING Exceptional Children*, 49(1), 7–17.
- Jitendra, A., DiPipi, C. M., & Perron-Jones, N. (2002). [An exploratory study of schema-based word-problem-solving instruction for middle school students with learning disabilities: An emphasis on conceptual and procedural understanding](#). *The Journal of Special Education*, 36, 23–38.
- Jitendra, A. K., Griffin, C. C., Deatline-Buchman, A., & Sczesniak, E. (2007). [Mathematical word problem solving in third-grade classrooms](#). *The Journal of Educational Research*, 100, 283–302.
- Jitendra, A. K., Griffin C. C., Haria P., Leh J., Adams A., & Kaduvettoor, A. (2007). [A comparison of single and multiple strategy instruction on third-grade students' mathematical problem solving](#). *Journal of Educational Psychology*, 99, 115–127.
- Jitendra, A. K., Lein, A. E., Im, S.-H., Alghamdi, A. A., Hefte, S. B., & Mouanoutoua, J. (2018). [Mathematical interventions for secondary students with learning disabilities and mathematics difficulties: A meta-](#)

analysis. *Exceptional Children*, 84, 177–196.

- Jitendra, A. K., & Star, J. R. (2011). Meeting the needs of students with learning disabilities in inclusive mathematics classrooms: The role of schema-based instruction on mathematical problem-solving. *Theory Into Practice*, 50, 12–19.
- Jitendra, A. K., & Star, J. R. (2012). An exploratory study contrasting high- and low-achieving students' percent word problem solving. *Learning and Individual Differences*, 22, 151–158.
- Kingsdorf, S. & Krawec, J. (2014). Error analysis of mathematical word problem solving across students with and without learning disabilities. *Learning Disabilities Research and Practice*, 29, 66–74.
- Kintsch, W., & Greeno, J. G. (1985). Understanding and solving word arithmetic problems. *Psychological Review*, 92, 109–120.
- Krawec, J. L. (2014). Problem representation and mathematical problem solving of students of varying math ability. *Journal of Learning Disabilities*, 47, 103–115.
- Krawec, J., Huang, J., Montague, M., Kressler, B., & de Alba, A. M. (2012). The effects of cognitive strategy instruction on knowledge of math problem-solving processes of middle school students with learning disabilities. *Learning Disability Quarterly*, 36, 80–92.
- Montague, M. (2008). Self-regulation strategies to improve mathematical problem solving for students with learning disabilities. *Learning Disability Quarterly*, 31, 37–44.
- Moschkovich, J. N. (2002). A situated and sociocultural perspective on bilingual mathematics learners. *Mathematical Thinking and Learning*, 4(2/3), 189–212.
- Peltier, C., & Vannest, K. J. (2018). Using the concrete representational abstract (CRA) instructional framework for mathematics with students with emotional and behavioral disorders. *Preventing School Failure*, 62(2), 73–82.
- Pólya, G. (1945). *How to solve it*. New York: Ishi Press.
- Powell, S. R. (2011). Solving word problems using schemas: A review of the literature. *Learning Disabilities Research and Practice*, 26(2), 94–108.
- Powell, S. R., Driver, M. K., Roberts, G., & Fall, A. (2017). An analysis of the mathematics vocabulary knowledge of third- and fifth-grade students: Connections to general vocabulary and mathematics computation. *Learning and Individual Differences*, 57, 22–32.
- Powell, S. R., Lin, X., & Boss, S. (2019). The assessment of mathematics vocabulary in the elementary and middle school grades. Submitted for publication.
- Powell, S. R., Stevens, E. A., & Hughes, E. M. (2018). Math language in middle school: Be more specific. *TEACHING Exceptional Children*, 51(4), 286–295.
- Riccomini, P. J., Smith, G. W., Hughes, E. M., & Fries, K. M. (2015). The language of mathematics: The importance of teaching and learning mathematical vocabulary. *Reading and Writing Quarterly*, 31, 235–252.

- Roberts, N. S., & Truxaw, M. P. (2013). For ELLs: Vocabulary beyond the definitions. *The Mathematics Teacher*, 107(1), 28–34.
- Rubenstein, R. N., & Thompson, D. R. (2002). Understanding and supporting children’s mathematical vocabulary development. *Teaching Children Mathematics*, 9, 107–112.
- Strickland, T. K. (2017). [Using the CRA-I strategy to develop conceptual and procedural knowledge of quadratic expressions.](#) *TEACHING Exceptional Children*, 49(2), 115–125.
- Strickland, T. K., & Maccini, P. (2013). [The Effects of the Concrete–Representational–Abstract Integration Strategy on the Ability of Students With Learning Disabilities to Multiply Linear Expressions Within Area Problems.](#) *Remedial and Special Education*, 34(3), 142–153.
- Van de Walle, J. A., Karp, K. S., & Bay-Williams, J. M. (2013). *Elementary and middle school mathematics: Teaching developmentally* (8th ed.). Pearson.
- Van Garderen, D., Scheuermann, A., & Jackson, C. (2012). [Developing representational ability in mathematics for students with learning disabilities: A content analysis of grades 6 and 7 textbooks.](#) *Learning Disability Quarterly*, 35, 24–38.
- Virginia Department of Education (2014). *Mathematics Instructional Connections for Physical and Visual Representations*.
- Witzel, B. S., Mercer, C. D., & Miller, M. D. (2003). [Teaching algebra to students with learning difficulties: An investigation of an explicit instruction model.](#) *Learning Disabilities Research and Practice*, 18, 121–131.
- Witzel, B. S., Riccomini, P. J., & Schneider, E. (2008). [Implementing CRA with secondary students with learning disabilities in mathematics.](#) *Intervention in School and Clinic*, 43, 270–276.
- Xin, Y. P., Jitendra, A. K., & Deatline-Buchman, A. (2005). [Effects of mathematical word problem solving instruction on middle school students with learning problems.](#) *Journal of Special Education*, 39, 181–192.
- Xin, Y. P., & Zhang, D. (2009). [Exploring a conceptual model-based approach to teaching situated word problems.](#) *The Journal of Educational Research*, 102, 427–441.

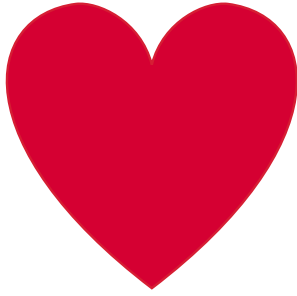

**VIRGINIA
IS FOR
LEARNERS**



© 2020, Commonwealth of Virginia Department of Education

The Virginia Department of Education does not discriminate on the basis of race, sex, color, national origin, religion, sexual orientation, gender identity, age, political affiliation, or against otherwise qualified persons with disabilities. The policy permits appropriate employment preferences for veterans and specifically prohibits discrimination against veterans.